

LWU701i/LW751i/LX801i/LWU601i/LW651i

**User's Manual (detailed)
Operating Guide - Technical**

020-000789-02
LIT MAN USR D2 TECH GUIDE

CHRISTIE®

LWU701i/LW751i/LX801i**LWU601i/LW651i****User's Manual (detailed)****Operating Guide – Technical**

Supported signals for COMPUTER IN

Resolution (H x V)	Signal mode	H. frequency (kHz)	V. frequency (Hz)	Rating
720 x 400	TEXT	37.9	85	VESA
640 x 480	VGA (60Hz)	31.5	59.9	VESA
	VGA (72Hz)	37.9	72.8	VESA
	VGA (75Hz)	37.5	75	VESA
	VGA (85Hz)	43.3	85	VESA
800 x 600	SVGA (56Hz)	35.2	56.3	VESA
	SVGA (60Hz)	37.9	60.3	VESA
	SVGA (72Hz)	48.1	72.2	VESA
	SVGA (75Hz)	46.9	75	VESA
	SVGA (85Hz)	53.7	85.1	VESA
832 x 624	Mac 16" mode	49.7	74.5	
1024 x 768	XGA (60Hz)	48.4	60	VESA
	XGA (70Hz)	56.5	70.1	VESA
	XGA (75Hz)	60	75	VESA
	XGA (85Hz)	68.7	85	VESA
1152 x 864	1152 x 864 (75Hz)	67.5	75	VESA
1280 x 768	W-XGA (60Hz)	47.7	60	VESA
1280 x 800	1280 x 800 (60Hz)	49.7	60	VESA
1280 x 1024	SXGA (60Hz)	64	60	VESA
	SXGA (75Hz)	80	75	VESA
	SXGA (85Hz)	91.1	85	VESA
*1 1366 x 768	WXGA (60Hz)	47.7	59.8	VESA
1440 x 900	WXGA+ (60Hz)	55.9	59.9	VESA
1600 x 900	WXGA++ (60Hz)	60	60	VESA
*2 1400 x 1050	SXGA+ (60Hz)	65.2	60	VESA
*3 1680 x 1050	WSXGA+ (60Hz)	65.3	60	VESA
1600 x 1200	UXGA (60Hz)	75	60	VESA
1920 x 1080	Full HD (60Hz)	67.5	60	VESA
*4 1920 x 1200	W-UXGA (60Hz) Reduced Blanking	74	60	VESA

*1) Supported except for [WUXGA Model]

*3) Only for [WXGA Model], [WUXGA Model]

*2) Only for [XGA Model]

*4) Only for [WUXGA Model]

(continued on next page)

Supported signals for HDMI / HDBaseT

Resolution (H x V)	Signal mode	H. frequency (kHz)	V. frequency (Hz)	Rating
720 x 400	TEXT	37.9	85	VESA
640 x 480	VGA (60Hz)	31.5	59.9	VESA
	VGA (72Hz)	37.9	72.8	VESA
	VGA (75Hz)	37.5	75	VESA
	VGA (85Hz)	43.3	85	VESA
800 x 600	SVGA (56Hz)	35.2	56.3	VESA
	SVGA (60Hz)	37.9	60.3	VESA
	SVGA (72Hz)	48.1	72.2	VESA
	SVGA (75Hz)	46.9	75	VESA
	SVGA (85Hz)	53.7	85.1	VESA
832 x 624	Mac 16" mode	49.7	74.5	
1024 x 768	XGA (60Hz)	48.4	60	VESA
	XGA (70Hz)	56.5	70.1	VESA
	XGA (75Hz)	60	75	VESA
	XGA (85Hz)	68.7	85	VESA
1152 x 864	1152 x 864 (75Hz)	67.5	75	VESA
1280 x 768	W-XGA (60Hz)	47.7	60	VESA
1280 x 800	1280 x 800 (60Hz)	49.7	60	VESA
1280 x 1024	SXGA (60Hz)	64	60	VESA
	SXGA (75Hz)	80	75	VESA
	SXGA (85Hz)	91.1	85	VESA
1366 x 768	WXGA (60Hz)	47.7	59.8	VESA
1440 x 900	WXGA+ (60Hz)	55.9	59.9	VESA
1600 x 900	WXGA++ (60Hz)	60	60	VESA
1400 x 1050	SXGA+ (60Hz)	65.2	60	VESA
1680 x 1050	WSXGA+ (60Hz)	65.3	60	VESA
1600 x 1200	UXGA (60Hz)	75	60	VESA
*1 1920 x 1200	W-UXGA (60Hz) Reduced Blanking	74	60	VESA

*1) Only for [WUXGA Model]

(continued on next page)

Resolution (H x V)	Signal mode	H. frequency (kHz)	V. frequency (Hz)	Rating
720(1440) x 480i	480i	15.7	60	CEA
720(1440) x 576i	576i	15.6	50	CEA
720 x 480p	480p	31.5	60	CEA
720 x 576p	576p	31.3	50	CEA
1280 x 720p	720p (50Hz)	37.5	50	CEA
	720p (60Hz)	45	60	CEA
1920 x 1080i	1080i (50Hz)	28.1	50	CEA
	1080i (60Hz)	33.8	60	CEA
1920 x 1080p	1080p (50Hz)	56.3	50	CEA
	1080p (60Hz)	67.5	60	CEA

(continued on next page)

Supported signals for DisplayPort

Resolution (H x V)	Signal mode	H. frequency (kHz)	V. frequency (Hz)	Rating
720 x 400	TEXT	37.9	85	VESA
640 x 480	VGA (60Hz)	31.5	59.9	VESA
	VGA (72Hz)	37.9	72.8	VESA
	VGA (75Hz)	37.5	75	VESA
	VGA (85Hz)	43.3	85	VESA
800 x 600	SVGA (56Hz)	35.2	56.3	VESA
	SVGA (60Hz)	37.9	60.3	VESA
	SVGA (72Hz)	48.1	72.2	VESA
	SVGA (75Hz)	46.9	75	VESA
	SVGA (85Hz)	53.7	85.1	VESA
832 x 624	Mac 16" mode	49.7	74.5	
1024 x 768	XGA (60Hz)	48.4	60	VESA
	XGA (70Hz)	56.5	70.1	VESA
	XGA (75Hz)	60	75	VESA
	XGA (85Hz)	68.7	85	VESA
1152 x 864	1152 x 864 (75Hz)	67.5	75	VESA
1280 x 768	W-XGA (60Hz)	47.7	60	VESA
1280 x 800	1280 x 800 (60Hz)	49.7	60	VESA
1280 x 1024	SXGA (60Hz)	64	60	VESA
	SXGA (75Hz)	80	75	VESA
	SXGA (85Hz)	91.1	85	VESA
1366 x 768	WXGA (60Hz)	47.7	59.8	VESA
1440 x 900	WXGA+ (60Hz)	55.9	59.9	VESA
1600 x 900	WXGA++ (60Hz)	60	60	VESA
1400 x 1050	SXGA+ (60Hz)	65.2	60	VESA
1680 x 1050	WSXGA+ (60Hz)	65.3	60	VESA
1600 x 1200	UXGA (60Hz)	75	60	VESA
*1 1920 x 1200	W-UXGA (60Hz) Reduced Blanking	74	60	VESA

*1) Only for [WUXGA Model]

(continued on next page)

Resolution (H x V)	Signal mode	H. frequency (kHz)	V. frequency (Hz)	Rating
720(1440) x 480i	480i	15.7	60	CEA
720(1440) x 576i	576i	15.6	50	CEA
720 x 480p	480p	31.5	60	CEA
720 x 576p	576p	31.3	50	CEA
1280 x 720p	720p (50Hz)	37.5	50	CEA
	720p (60Hz)	45	60	CEA
1920 x 1080i	1080i (50Hz)	28.1	50	CEA
	1080i (60Hz)	33.8	60	CEA
1920 x 1080p	1080p (50Hz)	56.3	50	CEA
	1080p (60Hz)	67.5	60	CEA

(continued on next page)

Supported signals for SDI

Resolution (H x V)	Signal mode	H. frequency (kHz)	V. frequency (Hz)	Rating
720 x 480i	480i	15.7	60	SMPTE
720 x 576i	576i	15.6	50	SMPTE
1280 x 720p	720p (50Hz)	37.5	50	SMPTE
	720p (60Hz)	45	60	SMPTE
1920 x 1080i	1080i (50Hz)	28.1	50	SMPTE
	1080i (60Hz)	33.8	60	SMPTE
1920 x 1080sf	1080i (25Hz)	28.1	50	SMPTE
	1080i (30Hz)	33.8	60	SMPTE
1920 x 1080p	1080p (50Hz)	56.3	50	SMPTE
	1080p (60Hz)	67.5	60	SMPTE

Only support 3G-SDI Level-A signal.

- NOTE**
- Be sure to check jack type, signal level, timing and resolution before connecting this projector to a PC.
 - Some PCs may have multiple display screen modes. Use of some of these modes is not possible with this projector.
 - Depending on the input signal, full-size display may not be possible in some cases. Refer to the number of display pixels above.
 - The signal is converted to the projector's panel resolution before being displayed. The best display performance is achieved if the resolutions of the input signal and projector panel are identical.
 - Automatic adjustment may not function correctly with some input signals.
 - The image may not be displayed correctly when the input sync signal is a composite sync or a sync on G.
 - The illustrations in this manual are for illustrative purposes. They may differ slightly from your projector.

Connection to the ports

NOTICE ▶ Use the cables with straight plugs, not L-shaped ones, as the input ports of the projector are recessed.
 ▶ Only the signal that is input from the **COMPUTER IN** can be output from the **MONITOR OUT** port.

LWU601i/LW651i/LW751i/
LX801i

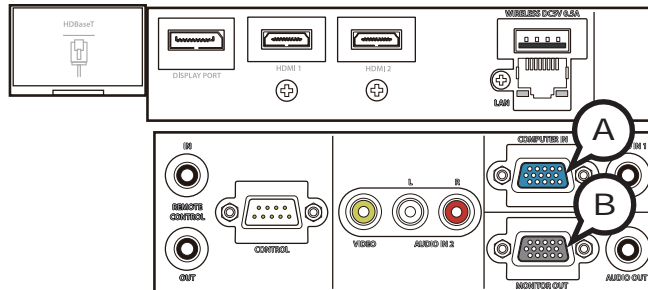

LWU701i

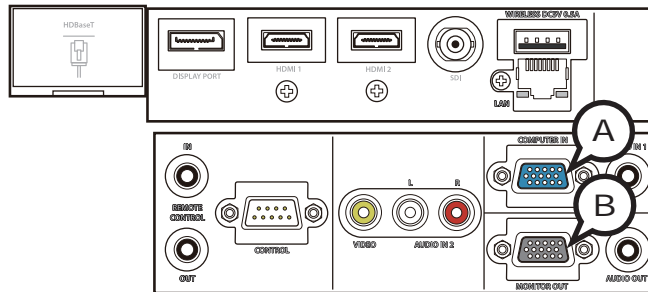

(A)COMPUTER IN, (B)MONITOR OUT

D-sub 15pin mini shrink jack

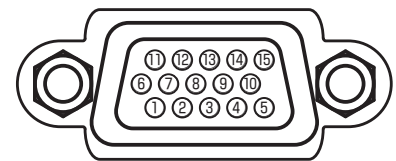

<Computer signal>

- Video signal: RGB separate, Analog, 0.7Vp-p, 75Ω terminated (positive)
- H/V. sync. signal: TTL level (positive/negative)
- Composite sync. signal: TTL level

<Component video signal>

- Video signal: Y with composite sync, Analog, 1.0±0.1Vp-p, 75Ω terminated
 Cb/Pb, Analog, 0.7±0.1Vp-p, 75Ω terminated
 Cr/Pr, Analog, 0.7±0.1Vp-p 75Ω terminated
- System: 480i@60, 480p@60, 576i@50, 720p@50/60, 1080i@50/60, 1080p@50/60

Pin	Signal	Pin	Signal
1	Video Red, Cr/Pr	9	(No connection)
2	Video Green, Y	10	Ground
3	Video Blue, Cb/Pb	11	(No connection)
4	(No connection)	12	(A): SDA (DDC data) (B): (No connection)
5	Ground	13	H. sync / Composite sync.
6	Ground Red, Ground Cr/Pr	14	V. sync.
7	Ground Green, Ground Y	15	(A): SCL (DDC clock) (B): (No connection)
8	Ground Blue, Ground Cb/Pb		

Connection to the ports (continued)

**LWU601i/LW651i/LW751i/
LX801i**

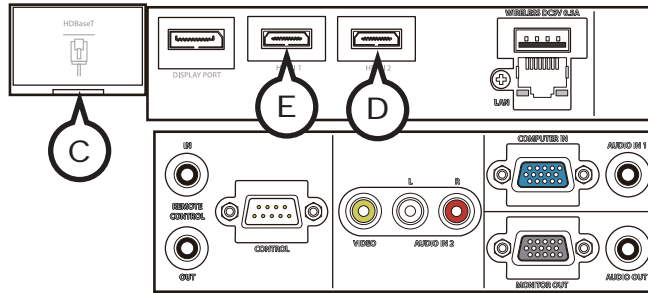

LWU701i

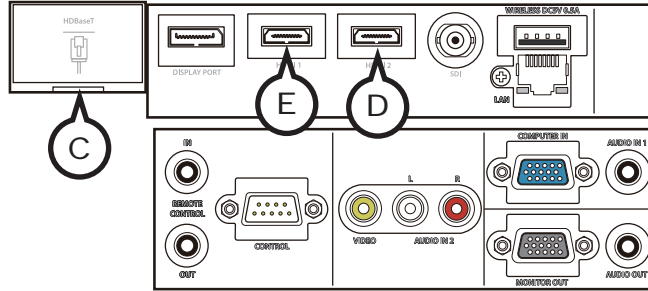

©HDBaseT

RJ-45 jack

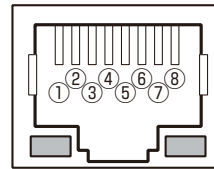

Pin	Signal	Pin	Signal	Pin	Signal
1	HDBaseT0+	4	HDBaseT2+	7	HDBaseT3+
2	HDBaseT0-	5	HDBaseT2-	8	HDBaseT3-
3	HDBaseT1+	6	HDBaseT1-		

ⓓHDMI 1, ⓔHDMI 2

HDMI™ connector

• Audio signal: Linear PCM (Sampling rate; 32/44.1/48 kHz)

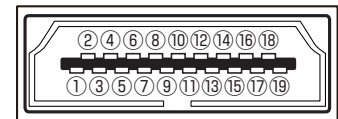

Pin	Signal	Pin	Signal	Pin	Signal
1	T.M.D.S. Data2 +	8	T.M.D.S. Data0 Shield	15	SCL
2	T.M.D.S. Data2 Shield	9	T.M.D.S. Data0 -	16	SDA
3	T.M.D.S. Data2 -	10	T.M.D.S. Clock +	17	DDC/CEC Ground
4	T.M.D.S. Data1 +	11	T.M.D.S. Clock Shield	18	+5V Power
5	T.M.D.S. Data1 Shield	12	T.M.D.S. Clock -	19	Hot Plug Detect
6	T.M.D.S. Data1 -	13	CEC		
7	T.M.D.S. Data0 +	14	Reserved (N.C. on device)		

**LWU601i/LW651i/LW751i/
LX801i**

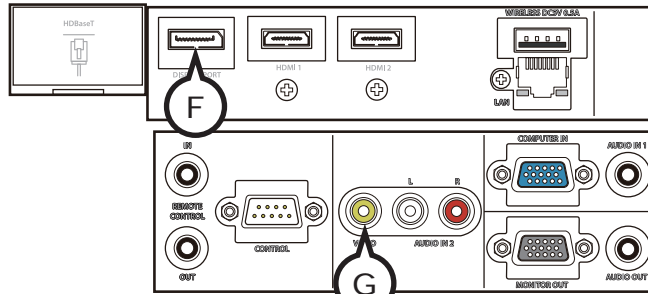

LWU701i

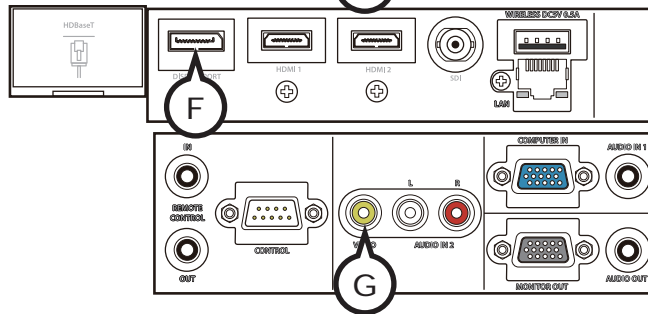

(F) DisplayPort

DisplayPort connector

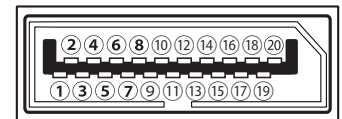

Pin	Signal	Pin	Signal	Pin	Signal
1	Main Link Lane 3 -	8	GND	15	AUX CH +
2	GND	9	Main Link Lane 1 +	16	GND
3	Main Link Lane 3 +	10	Main Link Lane 0 -	17	AUX CH -
4	Main Link Lane 2 -	11	GND	18	Hot Plug Detect
5	GND	12	Main Link Lane 0 +	19	Return
6	Main Link Lane 2 +	13	CONFIG 1	20	DP_PWR
7	Main Link Lane 1 -	14	CONFIG 2		

(G) VIDEO

RCA jack

- Composite video signal, Analog, 1.0±0.1Vp-p, 75Ω terminator
- System: NTSC, PAL, SECAM, PAL-M, PAL-N, NTSC4.43, PAL(60Hz)

Connection to the ports (continued)

**LWU601i/LW651i/LW751i/
LX801i**

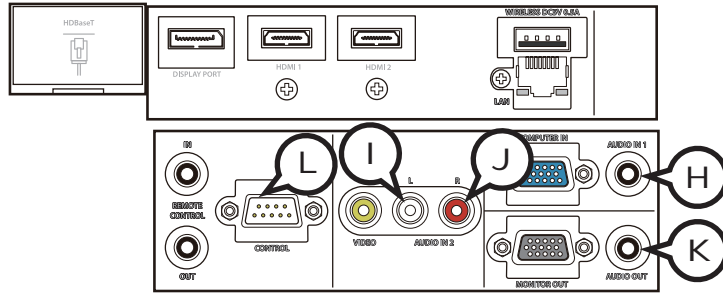

LWU701i

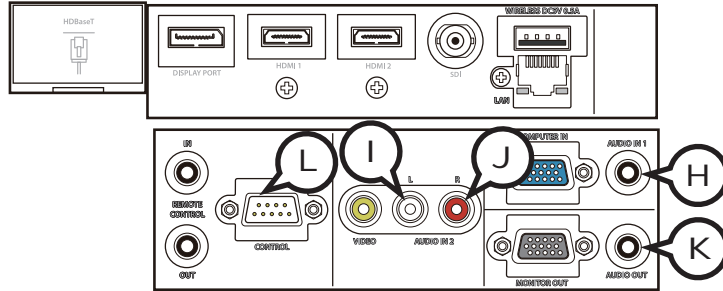

(H) AUDIO IN1

Ø3.5 stereo mini jack

- Analog, 47kΩ input impedance

AUDIO IN2 (I)L, (J)R

RCA jack x2

- Analog, 47kΩ input impedance

AUDIO OUT (K)

Ø3.5 stereo mini jack

- Analog, 1kΩ output impedance

(L) CONTROL

D-sub 9pin plug

* About the details of RS-232C communication, please refer to the next section.

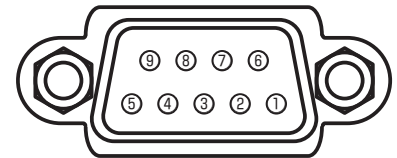

Pin	Signal	Pin	Signal	Pin	Signal
1	(No connection)	4	(No connection)	7	RTS
2	RD	5	Ground	8	CTS
3	TD	6	(No connection)	9	(No connection)

**LWU601i/LW651i/LW751i/
LX801i**

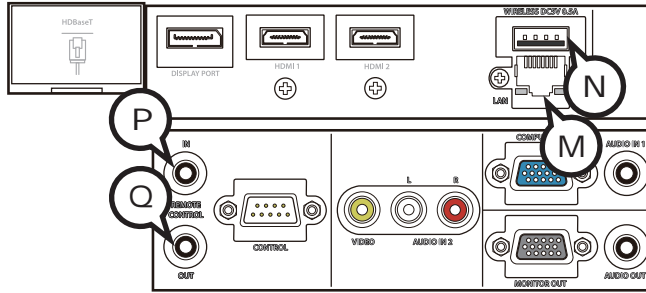

LWU701i

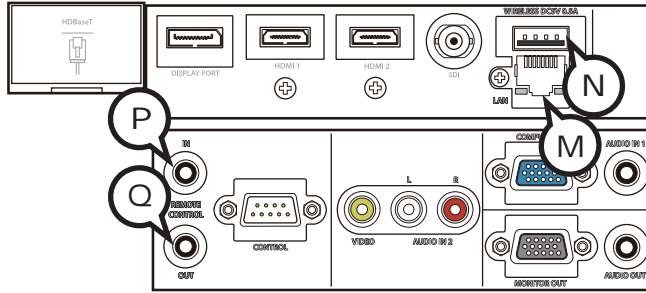

(M) LAN

RJ-45 jack

* About the details of network communication, please refer to the **Network Guide**.

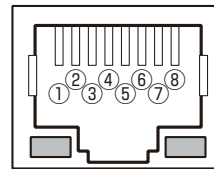

Pin	Signal	Pin	Signal	Pin	Signal
1	TX+	4	-	7	-
2	TX-	5	-	8	-
3	RX+	6	RX-		

(N) WIRELESS PORT

Only for USB wireless adapter.

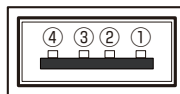

Pin	Signal
1	+5V
2	- Data
3	+ Data
4	Ground

REMOTE CONTROL (P)IN, (Q)OUT

Ø3.5 stereo mini jack

Connection to the ports (continued)

**LWU601i/LW651i/LW751i/
LX801i**

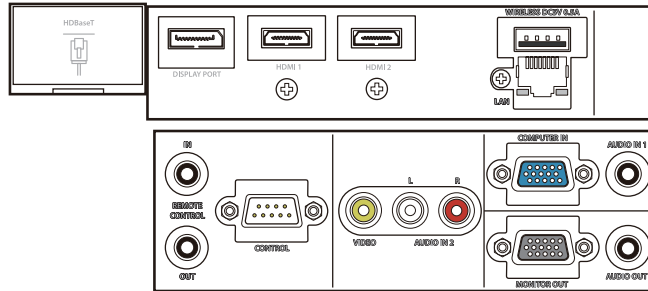

LWU701i

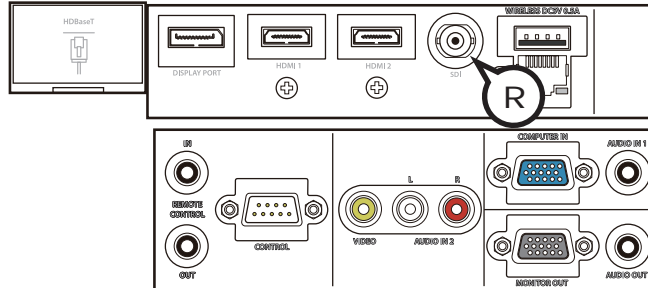

ⓇSDI

BNC jack

- SD/HD/3G-SDI signal, Digital, 0.8V±10%, 75Ω terminated

- System:

SD-SDI signal: conforming to SMPTE ST 259-C standard

YCBCR 4:2:2 10-bit

480i, 576i

Single link HD-SDI signal: conforming to SMPTE ST 292 standard

YPBPR 4:2:2 10-bit

720p@50/60, 1080i@50/60, 1080sf@25/30

3G-SDI Level-A signal: conforming to SMPTE ST 424 standard

YPBPR 4:2:2 10-bit

1080p@50/60

RS-232C Communication

When the projector connects to the computer by RS-232C communication, the projector can be controlled with RS-232C commands from the computer. For details of RS-232C commands, refer to RS-232C Communication / Network command table (📖22).

Connection

1. Turn off the projector and the computer.
2. Connect the projector's **CONTROL** port and the computer's RS-232C port with a RS-232C cable (cross). Use the cable that fulfills the specification shown in figure.
3. Turn the computer on, and after the computer has started up turn the projector on.
4. Set the COMMUNICATION TYPE to OFF in the COMMUNICATION menu of the OPTION - SERVICE menu.

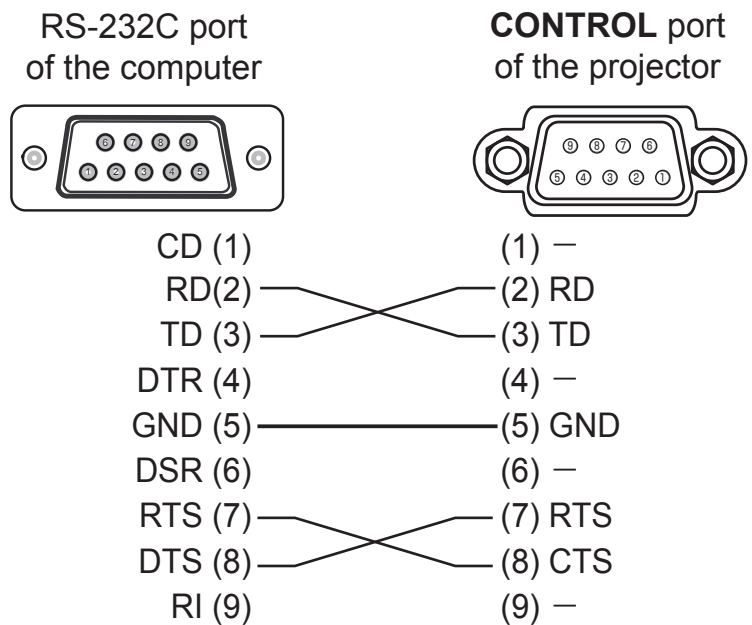
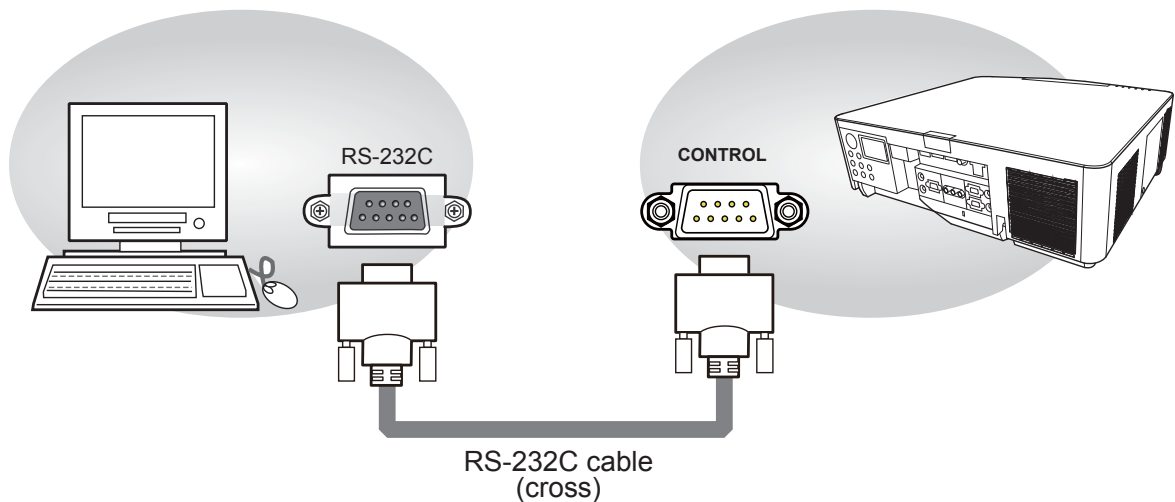

Communication settings

1. Protocol

19200bps, 8N1

2. Command format ("h" shows hexadecimal)

Byte Number	0	1	2	3	4	5	6	7	8	9	10	11	12
Command	Header						Data						
	Header code		Packet	Data size		CRC flag		Action		Type		Setting code	
	L	H		L	H	L	H	L	H	L	H	L	H
<SET>Change setting to desired value [(cL)(cH)] by [(bL)(bH)].	BEh	EFh	03h	06h	00h	(aL)	(aH)	01h	00h	(bL)	(bH)	(cL)	(cH)
<GET>Read projector internal setup value [(bL)(bH)] .						(aL)	(aH)	02h	00h	(bL)	(bH)	00h	00h
<INCREMENT> Increment setup value [(bL)(bH)] by 1.						(aL)	(aH)	04h	00h	(bL)	(bH)	00h	00h
<DECREMENT> Decrement setup value [(bL)(bH)] by 1.						(aL)	(aH)	05h	00h	(bL)	(bH)	00h	00h
<EXECUTE> Run a command [(bL)(bH)].						(aL)	(aH)	06h	00h	(bL)	(bH)	00h	00h

[Header code] [Packet] [Data size]

Set [BEh, EFh, 03h, 06h, 00h] to byte number 0 to 4.

[CRC flag]

For byte number 5, 6, refer to RS-232C Communication / Network command table (📖 19).

[Action]

Set functional code to byte number 7, 8.

<SET> = [01h, 00h], <GET> = [02h, 00h], <INCREMENT> = [04h, 00h]

<DECREMENT> = [05h, 00h], <EXECUTE> = [06h, 00h]

Refer to the Communication command table (📖 above).

[Type] [Setting code]

For byte number 9 to 12, refer to RS-232C Communication / Network command table (📖 19).

3. Response code / Error code ("h" shows hexadecimal)

(1) ACK reply: 06h

When the projector receives the Set, Increment, Decrement or Execute command correctly, the projector changes the setting data for the specified item by [Type], and it returns the code.

(2) NAK reply: 15h

When the projector cannot understand the received command, the projector returns the error code.

In such a case, check the sending code and send the same command again.

(3) Error reply: 1Ch + 0000h

When the projector cannot execute the received command for any reasons, the projector returns the error code.

In such a case, check the sending code and the setting status of the projector.

(4) Data reply: 1Dh + xxxh

When the projector receives the GET command correctly, the projector returns the response code and 2 bytes of data.

NOTE • For connecting the projector to your devices, read the manual for each devices, and connect them correctly with suitable cables.

- Operation cannot be guaranteed when the projector receives an undefined command or data.
- Provide an interval of at least 40ms between the response code and any other code.
- The projector outputs test data when the power supply is switched ON, and when the lamp is lit. Ignore this data.
- Commands are not accepted during warm-up.
- When the data length is greater than indicated by the data length code, the projector ignore the excess data code. Conversely when the data length is shorter than indicated by the data length code, the projector returns the error code to the computer.

Command Control via the Network

When the projector connects network, the projector can be controlled with RS-232C commands from the computer with web browser.

For details of RS-232C commands, refer to RS-232C Communication / Network command table (📖 19).

NOTE • If data is transferred using wireless and wired LAN at the same time, the projector may not be able to process the data correctly.

Connection

1. Turn off the projector and the computer.
2. If you use wired LAN, connect the projector's **LAN** or **HDBaseT™** port to the computer's LAN or **HDBaseT** port with a LAN cable. Use the cable that fulfills the specification shown in figure. If you use wireless LAN, insert the USB wireless adapter into the **WIRELESS** port of the projector.
3. Turn the computer on, and after the computer has started up turn the projector on.

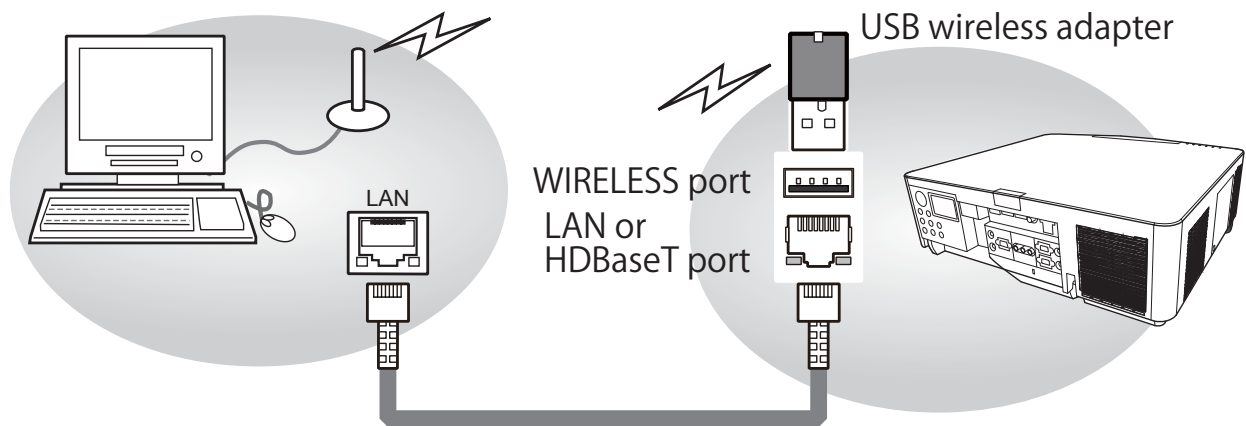

- LAN cable (CAT-5e or greater)
- or
- For HDBaseT connection
 - CAT-5e or greater
 - shielded type (connectors included)
 - straight cable
 - single cable

Communication Port

The following two ports are assigned for the command control.

- TCP #23
- TCP #9715

Configure the following items from a web browser when command control is used.

Port Settings		
Network Control Port1 (Port: 23)	Port open	Click the [Enable] checkbox to open [Network Control Port1 (Port: 23)] to use TCP #23. Default setting is Enable.
	Authentication	Click the [Enable] check box for the [Authentication] setting when authentication is required. Default setting is Disable.
Network Control Port2 (Port: 9715)	Port open	Click the [Enable] check box to open [Network Control Port2 (Port: 9715)] to use TCP #9715. Default setting is Enable.
	Authentication	Click the [Enable] check box for the [Authentication] setting when authentication is required. Default setting is Enable.

When the authentication setting is enabled, the following settings are required.

Security Settings		
Network Control	Authentication Password	Enter the required authentication password. Confirm this setting is the same for [Network Control Port1 (Port: 23)] and [Network Control Port2 (Port: 9715)] . Default setting is blank.
	Re-enter Authentication Password	

Command control settings

[TCP #23]

1. Command format

Same as RS-232C communication, refer to RS-232C Communication command format.

2. Response code / Error code ("h" shows hexadecimal)

Four of the response / error code used for TCP#23 are the same as RS-232C Communication (1)~(4). One authentication error reply (5) is added.

(1) ACK reply : 06h

Refer to RS-232C communication (📖 13).

(2) NAK reply : 15h

Refer to RS-232C communication (📖 13).

(3) Error reply : 1Ch + 0000h

Refer to RS-232C communication (📖 13).

(4) Data reply : 1Dh + xxxxh

Refer to RS-232C communication (📖 13).

(5) Authentication error reply : 1Fh + 0400h

When authentication error occurred, the projector returns the error code.

[TCP #9715]

1. Command format

The commands some datum are added to the head and the end of the ones of TCP#9715 are used.

Header	Data length	RS-232C command	Check sum	Connection ID
0x02	0x0D	13 bytes	1 byte	1 byte

[Header]

02, Fixed

[Data Length]

RS-232C commands byte length (0x0D, Fixed)

[RS-232C commands]

Refer to RS-232C Communication command format (📖 14).

[Check Sum]

This is the value to make zero on the addition of the lower 8 bits from the header to the checksum.

[Connection ID]

Random value from 0 to 255 (This value is attached to the reply data).

NOTE • Operation cannot be guaranteed when the projector receives an undefined command or data.

- Provide an interval of at least 40ms between the response code and any other code.
- Commands are not accepted during warm-up.

2. Response code / Error code ("h" shows hexadecimal)

The connection ID is attached for the TCP#23's response / error codes are used. The connection ID is same as the sending command format.

- (1) **ACK reply:** 06h + xxh (xxh : connection ID)
- (2) **NAK reply:** 15h + xxh
- (3) **Error reply:** 1Ch + 0000h + xxh
- (4) **Data reply:** 1Dh + xxxh + xxh
- (5) **Authentication error reply:** 1Fh + 0400h + xxh
- (6) **Projector busy reply:** 1Fh + xxxh + xxh

When the projector is too busy to receive the command, the projector returns the error code.

In such a case, check the sending code and send the same command again.

Automatic Connection Break

The TCP connection is automatically disconnected after there is no communication for 30 seconds after being established.

Authentication

The projector does not accept commands without authentication success when authentication is enabled. The projector uses a challenge response type authentication with an MD5 (Message Digest 5) algorithm.

When the projector is connected to a LAN, a random 8 bytes is returned if authentication is enabled. Bind this received 8 bytes and the authentication password, and digest the data with the MD5 algorithm, and add it in front of the commands to send.

The following is a sample of authentication process.

Authentication password: **password** (example)

Random 8 bytes: **a572f60c** (example)

- 1) Select a projector and receive the random 8 bytes from the projector.
→ "a572f60c"
- 2) Bind the random 8 bytes and the authentication password.
→ "a572f60cpassword"
- 3) Digest this bound with MD5 algorithm.
→ "e3d97429adffa11bce1f7275813d4bde"
- 4) Add this code in front of the commands and send the data.
→ "e3d97429adffa11bce1f7275813d4bde" + [command].
- 5) When the sent data is correct, the command is performed and the reply data is returned. Otherwise, an authentication error is returned.

NOTE • As for the transmission of the second or subsequent commands, the authentication data can be omitted for the same connection.

Network Bridge Communication

This projector is equipped with NETWORK BRIDGE function. When the projector connects to the computer by wired or wireless LAN communication, an external device connected with this projector by RS-232C communication can be controlled from the computer as a network terminal. For details, see the **7. Network Bridge** function in the **Network Guide**.

NOTE • If data is transferred using wireless and wired LAN at the same time, the projector may not be able to process the data correctly.

Connection

1. If you use wired LAN, connect the computer's LAN port and the projector's **LAN** port with a LAN cable. Use the cable that fulfills the specification shown in figure. If you use wireless LAN, insert the USB wireless adapter into the projector's **LAN** port.
2. Connect the projector's **CONTROL** port and the RS-232C port of the devices that you want to control with a RS-232C cable.
3. Turn the computer on, and after the computer has started up turn the projector on.
4. Set the COMMUNICATION TYPE to NETWORK BRIDGE in the COMMUNICATION menu of the OPTION - SERVICE menu.

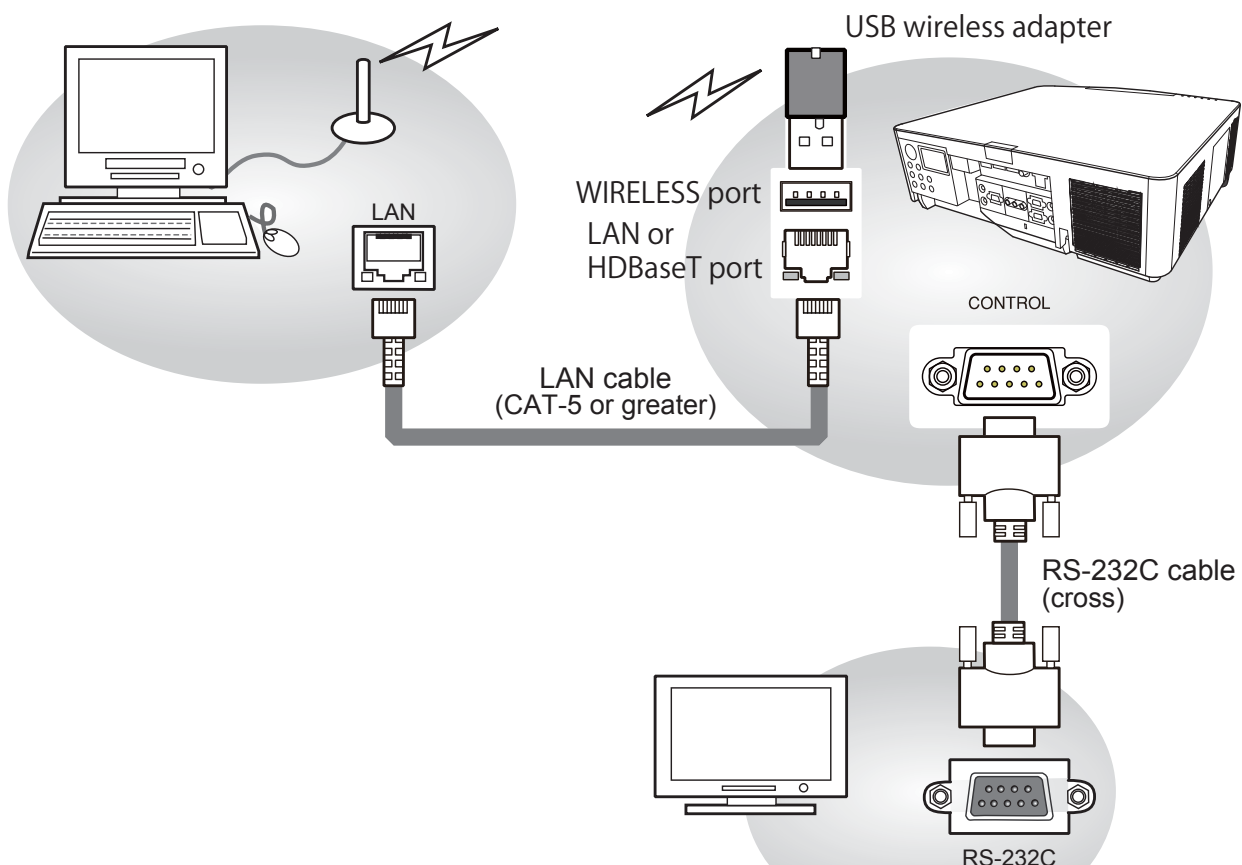

Communication settings

For communication setting, use the COMMUNICATION menu in the OPTION - SERVICE menu

Item	Condition
BAUD RATE	4800bps / 9600bps / 19200bps / 38400bps
Data length	8 bit (fixed)
PARITY	NONE/ODD/EVEN
Start bit	1 bit (fixed)
Stop bit	1 bit (fixed)
Transmission method	HALF-DUPLEX/FULL-DUPLEX

NOTE • For connecting the projector to your devices, read the manual for each devices, and connect them correctly with suitable cables.

- Turn off the power and unplug both the projector and other devices before connecting them.
- For details of Transmission method, refer to **7.4 Transmission method** in the **Network Guide**.

RS-232C Communication / Network command table

Names	Operation Type	Header				CRC	Command Data		
		Action	Type	Setting code					
Power	Set	Turn off	BE EF	03	06 00	2A D3	01 00	00 60	00 00
		Turn on	BE EF	03	06 00	BA D2	01 00	00 60	01 00
	Get	[Example return] 00 00 01 00 02 00 [Off] [On] [Cool down]							
Input Source	Set	COMPUTER IN	BE EF	03	06 00	FE D2	01 00	00 20	00 00
		LAN	BE EF	03	06 00	CE D5	01 00	00 20	0B 00
		HDMI 1	BE EF	03	06 00	0E D2	01 00	00 20	03 00
		HDMI 2	BE EF	03	06 00	6E D6	01 00	00 20	0D 00
		HDBaseT	BE EF	03	06 00	AE DE	01 00	00 20	11 00
		VIDEO	BE EF	03	06 00	6E D3	01 00	00 20	01 00
		SDI*	BE EF	03	06 00	5E DE	01 00	00 20	12 00
	DisplayPort	BE EF	03	06 00	CE DF	01 00	00 20	13 00	
Get	BE EF 03 06 00 CD D2 02 00 00 20 00 00								
Error Status	Get	[Example return] 00 00 01 00 02 00 03 00 [Normal] [Cover error] [Fan error] [Lamp error] 04 00 05 00 07 00 08 00 [Temp error] [Air flow error] [Cold error] [Filter error] 0F 00 10 00 60 00 [Shutter error][Lens Shift error][AC blackout error]							
FOCUS	Increment	BE EF	03	06 00	6A 93	04 00	00 24	00 00	
	Decrement	BE EF	03	06 00	BB 92	05 00	00 24	00 00	
ZOOM	Increment	BE EF	03	06 00	96 92	04 00	01 24	00 00	
	Decrement	BE EF	03	06 00	47 93	05 00	01 24	00 00	
LENS SHIFT - V	Increment	BE EF	03	06 00	D2 92	04 00	02 24	00 00	
	Decrement	BE EF	03	06 00	03 93	05 00	02 24	00 00	
LENS SHIFT - H	Increment	BE EF	03	06 00	2E 93	04 00	03 24	00 00	
	Decrement	BE EF	03	06 00	FF 92	05 00	03 24	00 00	
LENS SHIFT CENTERING	Execute	BE EF	03	06 00	B8 93	06 00	04 24	00 00	
LENS MEMORY INDEX	Set	1	BE EF	03	06 00	4B 92	01 00	07 24	00 00
		2	BE EF	03	06 00	DB 93	01 00	07 24	01 00
		3	BE EF	03	06 00	2B 93	01 00	07 24	02 00
	Get	BE EF 03 06 00 78 92 02 00 07 24 00 00							
LENS MEMORY LOAD	Execute	BE EF	03	06 00	E8 90	06 00	08 24	00 00	
LENS MEMORY SAVE	Execute	BE EF	03	06 00	14 91	06 00	09 24	00 00	
LENS MEMORY CLEAR	Execute	BE EF	03	06 00	50 91	06 00	0A 24	00 00	

* Supported only for LWU701i

Names	Operation Type	Header			CRC	Command Data			
						Action	Type	Setting code	
LENS MEMORY LENS SHIFT - V	Get	BE EF	03	06 00	A0 91	02 00	0D 24	00 00	
LENS MEMORY LENS SHIFT - H	Get	BE EF	03	06 00	E4 91	02 00	0E 24	00 00	
LENS MEMORY LENS TYPE	Get	BE EF	03	06 00	18 90	02 00	0F 24	00 00	
MAGNIFY	Get	BE EF	03	06 00	7C D2	02 00	07 30	00 00	
	Increment	BE EF	03	06 00	1A D2	04 00	07 30	00 00	
	Decrement	BE EF	03	06 00	CB D3	05 00	07 30	00 00	
MAGNIFY Position H	Get	BE EF	03	06 00	C8 D7	02 00	10 30	00 00	
	Increment	BE EF	03	06 00	AE D7	04 00	10 30	00 00	
	Decrement	BE EF	03	06 00	7F D6	05 00	10 30	00 00	
MAGNIFY Position V	Get	BE EF	03	06 00	34 D6	02 00	11 30	00 00	
	Increment	BE EF	03	06 00	52 D6	04 00	11 30	00 00	
	Decrement	BE EF	03	06 00	83 D7	05 00	11 30	00 00	
FREEZE	Set	NORMAL	BE EF	03	06 00	83 D2	01 00	02 30	00 00
		FREEZE	BE EF	03	06 00	13 D3	01 00	02 30	01 00
	Get	BE EF	03	06 00	B0 D2	02 00	02 30	00 00	
SHUTTER	Set	OFF	BE EF	03	06 00	F3 93	01 00	05 24	00 00
		ON	BE EF	03	06 00	63 92	01 00	05 24	01 00
	Get	BE EF	03	06 00	C0 93	02 00	05 24	00 00	
PbyP/PIP	Set	OFF	BE EF	03	06 00	3E 26	01 00	10 23	00 00
		PbyP	BE EF	03	06 00	AE 27	01 00	10 23	01 00
		PIP	BE EF	03	06 00	5E 27	01 00	10 23	02 00
	Get	BE EF	03	06 00	0D 26	02 00	10 23	00 00	
PbyP MAIN SIZE	Set	SMALL	BE EF	03	06 00	F2 07	01 00	11 23	7F 00
		MIDDLE	BE EF	03	06 00	02 46	01 00	11 23	80 00
		LARGE	BE EF	03	06 00	92 47	01 00	11 23	81 00
	Get	BE EF	03	06 00	F1 27	02 00	11 23	00 00	
PbyP RIGHT SOURCE	Set	COMPUTER IN	BE EF	03	06 00	86 27	01 00	12 23	00 00
		HDMI 1	BE EF	03	06 00	76 27	01 00	12 23	03 00
		HDMI 2	BE EF	03	06 00	16 23	01 00	12 23	0D 00
		HDBaseT	BE EF	03	06 00	D6 2B	01 00	12 23	11 00
		VIDEO	BE EF	03	06 00	16 26	01 00	12 23	01 00
		SDI*	BE EF	03	06 00	26 2B	01 00	12 23	12 00
	DisplayPort	BE EF	03	06 00	B6 2A	01 00	12 23	13 00	
Get	BE EF	03	06 00	B5 27	02 00	12 23	00 00		
PbyP MAIN AREA	Set	LEFT	BE EF	03	06 00	7A 26	01 00	13 23	00 00
		RIGHT	BE EF	03	06 00	EA 27	01 00	13 23	01 00
	Get	BE EF	03	06 00	49 26	02 00	13 23	00 00	
PbyP LEFT SOURCE	Set	COMPUTER IN	BE EF	03	06 00	F2 26	01 00	15 23	00 00
		HDMI 1	BE EF	03	06 00	02 26	01 00	15 23	03 00
		HDMI 2	BE EF	03	06 00	62 22	01 00	15 23	0D 00
		HDBaseT	BE EF	03	06 00	A2 2A	01 00	15 23	11 00
		VIDEO	BE EF	03	06 00	62 27	01 00	15 23	01 00
		SDI*	BE EF	03	06 00	52 2A	01 00	15 23	12 00
	DisplayPort	BE EF	03	06 00	C2 2B	01 00	15 23	13 00	
Get	BE EF	03	06 00	C1 26	02 00	15 23	00 00		

* Supported only for LWU701i

Names	Operation Type	Header			CRC	Command Data			
						Action	Type	Setting code	
PIP POSITION	Set	TOP LEFT	BE EF	03	06 00	02 23	01 00	01 23	00 00
		TOP RIGHT	BE EF	03	06 00	92 22	01 00	01 23	01 00
		BOTTOM LEFT	BE EF	03	06 00	62 22	01 00	01 23	02 00
		BOTTOM RIGHT	BE EF	03	06 00	F2 23	01 00	01 23	03 00
	Get	BE EF	03	06 00	31 23	02 00	01 23	00 00	
PIP MAIN AREA	Set	PRIMARY	BE EF	03	06 00	32 22	01 00	05 23	00 00
		SECONDARY	BE EF	03	06 00	A2 23	01 00	05 23	01 00
	Get	BE EF	03	06 00	01 22	02 00	05 23	00 00	
PIP PRIMARY SOURCE	Set	COMPUTER IN	BE EF	03	06 00	CE 23	01 00	04 23	00 00
		HDMI 1	BE EF	03	06 00	3E 23	01 00	04 23	03 00
		HDMI 2	BE EF	03	06 00	5E 27	01 00	04 23	0D 00
		HDBaseT	BE EF	03	06 00	9E 2F	01 00	04 23	11 00
		VIDEO	BE EF	03	06 00	5E 22	01 00	04 23	01 00
		SDI*	BE EF	03	06 00	6E 2F	01 00	04 23	12 00
	DisplayPort	BE EF	03	06 00	FE 2E	01 00	04 23	13 00	
Get	BE EF	03	06 00	FD 23	02 00	04 23	00 00		
PIP SECONDARY SOURCE	Set	COMPUTER IN	BE EF	03	06 00	46 23	01 00	02 23	00 00
		HDMI 1	BE EF	03	06 00	B6 23	01 00	02 23	03 00
		HDMI 2	BE EF	03	06 00	D6 27	01 00	02 23	0D 00
		HDBaseT	BE EF	03	06 00	16 2F	01 00	02 23	11 00
		VIDEO	BE EF	03	06 00	D6 22	01 00	02 23	01 00
		SDI*	BE EF	03	06 00	E6 2F	01 00	02 23	12 00
	DisplayPort	BE EF	03	06 00	76 2E	01 00	02 23	13 00	
Get	BE EF	03	06 00	75 23	02 00	02 23	00 00		
PbyP/PIP SWAP	Execute	BE EF	03	06 00	01 27	06 00	16 23	00 00	
PbyP / PIP FRAME LOCK	Set	LEFT / PRIMARY	BE EF	03	06 00	4A 27	01 00	17 23	00 00
		RIGHT / SECONDARY	BE EF	03	06 00	DA 26	01 00	17 23	01 00
	Get	BE EF	03	06 00	79 27	02 00	17 23	00 00	
PICTURE MODE	Set	STANDARD	BE EF	03	06 00	83 F5	01 00	BA 30	06 00
		NATURAL	BE EF	03	06 00	23 F6	01 00	BA 30	00 00
		CINEMA	BE EF	03	06 00	B3 F7	01 00	BA 30	01 00
		DYNAMIC	BE EF	03	06 00	E3 F4	01 00	BA 30	04 00
		BOARD(BLACK)	BE EF	03	06 00	E3 EF	01 00	BA 30	20 00
		BOARD(GREEN)	BE EF	03	06 00	73 EE	01 00	BA 30	21 00
		WHITEBOARD	BE EF	03	06 00	83 EE	01 00	BA 30	22 00
		DAYTIME	BE EF	03	06 00	E3 C7	01 00	BA 30	40 00
		DICOM SIM.	BE EF	03	06 00	73 C6	01 00	BA 30	41 00
		USER-1	BE EF	03	06 00	E3 FB	01 00	BA 30	10 00
		USER-2	BE EF	03	06 00	73 FA	01 00	BA 30	11 00
	USER-3	BE EF	03	06 00	83 FA	01 00	BA 30	12 00	
	Get	BE EF	03	06 00	10 F6	02 00	BA 30	00 00	
[Example return]									
		00 00			01 00		04 00		
		[NORMAL]			[CINEMA]		[DYNAMIC]		
		20 00			21 00		22 00		
		[BOARD(BLACK)]			[BOARD(GREEN)]		[WHITEBOARD]		
		40 00			41 00		10 00		
		[DAY TIME]			[DICOM SIM.]		[Custom]		

* Supported only for LWU701i

Names	Operation Type	Header			CRC	Command Data			
						Action	Type	Setting code	
BRIGHTNESS	Get	BE EF	03	06 00	89 D2	02 00	03 20	00 00	
	Increment	BE EF	03	06 00	EF D2	04 00	03 20	00 00	
	Decrement	BE EF	03	06 00	3E D3	05 00	03 20	00 00	
BRIGHTNESS Reset	Execute	BE EF	03	06 00	58 D3	06 00	00 70	00 00	
CONTRAST	Get	BE EF	03	06 00	FD D3	02 00	04 20	00 00	
	Increment	BE EF	03	06 00	9B D3	04 00	04 20	00 00	
	Decrement	BE EF	03	06 00	4A D2	05 00	04 20	00 00	
CONTRAST Reset	Execute	BE EF	03	06 00	A4 D2	06 00	01 70	00 00	
GAMMA	Set	1 DEFAULT	BE EF	03	06 00	07 E9	01 00	A1 30	20 00
		1 CUSTOM	BE EF	03	06 00	07 FD	01 00	A1 30	10 00
		2 DEFAULT	BE EF	03	06 00	97 E8	01 00	A1 30	21 00
		2 CUSTOM	BE EF	03	06 00	97 FC	01 00	A1 30	11 00
		3 DEFAULT	BE EF	03	06 00	67 E8	01 00	A1 30	22 00
		3 CUSTOM	BE EF	03	06 00	67 FC	01 00	A1 30	12 00
		4 DEFAULT	BE EF	03	06 00	F7 E9	01 00	A1 30	23 00
		4 CUSTOM	BE EF	03	06 00	F7 FD	01 00	A1 30	13 00
		5 DEFAULT	BE EF	03	06 00	C7 EB	01 00	A1 30	24 00
		5 CUSTOM	BE EF	03	06 00	C7 FF	01 00	A1 30	14 00
		6 DEFAULT	BE EF	03	06 00	57 EA	01 00	A1 30	25 00
		6 CUSTOM	BE EF	03	06 00	57 FE	01 00	A1 30	15 00
		7 DEFAULT	BE EF	03	06 00	A7 EA	01 00	A1 30	26 00
		7 CUSTOM	BE EF	03	06 00	A7 FE	01 00	A1 30	16 00
		8 DEFAULT	BE EF	03	06 00	37 EB	01 00	A1 30	27 00
		8 CUSTOM	BE EF	03	06 00	37 FF	01 00	A1 30	17 00
		Get	BE EF	03	06 00	F4 F0	02 00	A1 30	00 00
User GAMMA Point 1	Get	BE EF	03	06 00	08 FE	02 00	90 30	00 00	
	Increment	BE EF	03	06 00	6E FE	04 00	90 30	00 00	
	Decrement	BE EF	03	06 00	BF FF	05 00	90 30	00 00	
User GAMMA Point 1 Reset	Execute	BE EF	03	06 00	58 C2	06 00	50 70	00 00	
User GAMMA Point 2	Get	BE EF	03	06 00	F4 FF	02 00	91 30	00 00	
	Increment	BE EF	03	06 00	92 FF	04 00	91 30	00 00	
	Decrement	BE EF	03	06 00	43 FE	05 00	91 30	00 00	
User GAMMA Point 2 Reset	Execute	BE EF	03	06 00	A4 C3	06 00	51 70	00 00	
User GAMMA Point 3	Get	BE EF	03	06 00	B0 FF	02 00	92 30	00 00	
	Increment	BE EF	03	06 00	D6 FF	04 00	92 30	00 00	
	Decrement	BE EF	03	06 00	07 FE	05 00	92 30	00 00	
User GAMMA Point 3 Reset	Execute	BE EF	03	06 00	E0 C3	06 00	52 70	00 00	

Names	Operation Type	Header			CRC	Command Data			
						Action	Type	Setting code	
User GAMMA Point 4	Get	BE EF	03	06 00	4C FE	02 00	93 30	00 00	
	Increment	BE EF	03	06 00	2A FE	04 00	93 30	00 00	
	Decrement	BE EF	03	06 00	FB FF	05 00	93 30	00 00	
User GAMMA Point 4 Reset	Execute	BE EF	03	06 00	1C C2	06 00	53 70	00 00	
User GAMMA Point 5	Get	BE EF	03	06 00	38 FF	02 00	94 30	00 00	
	Increment	BE EF	03	06 00	5E FF	04 00	94 30	00 00	
	Decrement	BE EF	03	06 00	8F FE	05 00	94 30	00 00	
User GAMMA Point 5 Reset	Execute	BE EF	03	06 00	68 C3	06 00	54 70	00 00	
User GAMMA Point 6	Get	BE EF	03	06 00	C4 FE	02 00	95 30	00 00	
	Increment	BE EF	03	06 00	A2 FE	04 00	95 30	00 00	
	Decrement	BE EF	03	06 00	73 FF	05 00	95 30	00 00	
User GAMMA Point 6 Reset	Execute	BE EF	03	06 00	94 C2	06 00	55 70	00 00	
User GAMMA Point 7	Get	BE EF	03	06 00	80 FE	02 00	96 30	00 00	
	Increment	BE EF	03	06 00	E6 FE	04 00	96 30	00 00	
	Decrement	BE EF	03	06 00	37 FF	05 00	96 30	00 00	
User GAMMA Point 7 Reset	Execute	BE EF	03	06 00	D0 C2	06 00	56 70	00 00	
User GAMMA Point 8	Get	BE EF	03	06 00	7C FF	02 00	97 30	00 00	
	Increment	BE EF	03	06 00	1A FF	04 00	97 30	00 00	
	Decrement	BE EF	03	06 00	CB FE	05 00	97 30	00 00	
User GAMMA Point 8 Reset	Execute	BE EF	03	06 00	2C C3	06 00	57 70	00 00	
COLOR TEMP	Set	1 HIGH	BE EF	03	06 00	0B F5	01 00	B0 30	03 00
		1 CUSTOM(HIGH)	BE EF	03	06 00	CB F8	01 00	B0 30	13 00
		2 MID-1	BE EF	03	06 00	9B F4	01 00	B0 30	02 00
		2 CUSTOM(MID-1)	BE EF	03	06 00	5B F9	01 00	B0 30	12 00
		3 MID-2	BE EF	03	06 00	3B F7	01 00	B0 30	04 00
		3 CUSTOM (MID-2)	BE EF	03	06 00	FB FA	01 00	B0 30	14 00
		3 LOW	BE EF	03	06 00	6B F4	01 00	B0 30	01 00
		4 CUSTOM(LOW)	BE EF	03	06 00	AB F9	01 00	B0 30	11 00
		4 Hi-BRIGHT-1	BE EF	03	06 00	3B F2	01 00	B0 30	08 00
		5 CUSTOM	BE EF	03	06 00	FB FF	01 00	B0 30	18 00
		5 Hi-BRIGHT-2	BE EF	03	06 00	AB F3	01 00	B0 30	09 00
		6 CUSTOM	BE EF	03	06 00	6B FE	01 00	B0 30	19 00
	6 Hi-BRIGHT-3	BE EF	03	06 00	5B F3	01 00	B0 30	0A 00	
7 CUSTOM	BE EF	03	06 00	9B FE	01 00	B0 30	1A 00		
Get	BE EF	03	06 00	C8 F5	02 00	B0 30	00 00		

Names	Operation Type	Header			CRC	Command Data		
						Action	Type	Setting code
COLOR TEMP GAIN R	Get	BE EF	03	06 00	34 F4	02 00	B1 30	00 00
	Increment	BE EF	03	06 00	52 F4	04 00	B1 30	00 00
	Decrement	BE EF	03	06 00	83 F5	05 00	B1 30	00 00
COLOR TEMP GAIN R Reset	Execute	BE EF	03	06 00	10 C6	06 00	46 70	00 00
COLOR TEMP GAIN G	Get	BE EF	03	06 00	70 F4	02 00	B2 30	00 00
	Increment	BE EF	03	06 00	16 F4	04 00	B2 30	00 00
	Decrement	BE EF	03	06 00	C7 F5	05 00	B2 30	00 00
COLOR TEMP GAIN G Reset	Execute	BE EF	03	06 00	EC C7	06 00	47 70	00 00
COLOR TEMP GAIN B	Get	BE EF	03	06 00	8C F5	02 00	B3 30	00 00
	Increment	BE EF	03	06 00	EA F5	04 00	B3 30	00 00
	Decrement	BE EF	03	06 00	3B F4	05 00	B3 30	00 00
COLOR TEMP GAIN B Reset	Execute	BE EF	03	06 00	F8 C4	06 00	48 70	00 00
COLOR TEMP OFFSET R	Get	BE EF	03	06 00	04 F5	02 00	B5 30	00 00
	Increment	BE EF	03	06 00	62 F5	04 00	B5 30	00 00
	Decrement	BE EF	03	06 00	B3 F4	05 00	B5 30	00 00
COLOR TEMP OFFSET R Reset	Execute	BE EF	03	06 00	40 C5	06 00	4A 70	00 00
COLOR TEMP OFFSET G	Get	BE EF	03	06 00	40 F5	02 00	B6 30	00 00
	Increment	BE EF	03	06 00	26 F5	04 00	B6 30	00 00
	Decrement	BE EF	03	06 00	F7 F4	05 00	B6 30	00 00
COLOR TEMP OFFSET G Reset	Execute	BE EF	03	06 00	BC C4	06 00	4B 70	00 00
COLOR TEMP OFFSET B	Get	BE EF	03	06 00	BC F4	02 00	B7 30	00 00
	Increment	BE EF	03	06 00	DA F4	04 00	B7 30	00 00
	Decrement	BE EF	03	06 00	0B F5	05 00	B7 30	00 00
COLOR TEMP OFFSET B Reset	Execute	BE EF	03	06 00	C8 C5	06 00	4C 70	00 00
COLOR	Get	BE EF	03	06 00	B5 72	02 00	02 22	00 00
	Increment	BE EF	03	06 00	D3 72	04 00	02 22	00 00
	Decrement	BE EF	03	06 00	02 73	05 00	02 22	00 00
COLOR Reset	Execute	BE EF	03	06 00	80 D0	06 00	0A 70	00 00

RS-232C Communication / Network command table (continued)

Names	Operation Type	Header			CRC	Command Data			
						Action	Type	Setting code	
TINT	Get	BE EF	03	06 00	49 73	02 00	03 22	00 00	
	Increment	BE EF	03	06 00	2F 73	04 00	03 22	00 00	
	Decrement	BE EF	03	06 00	FE 72	05 00	03 22	00 00	
TINT Reset	Execute	BE EF	03	06 00	7C D1	06 00	0B 70	00 00	
SHARPNESS	Get	BE EF	03	06 00	F1 72	02 00	01 22	00 00	
	Increment	BE EF	03	06 00	97 72	04 00	01 22	00 00	
	Decrement	BE EF	03	06 00	46 73	05 00	01 22	00 00	
SHARPNESS Reset	Execute	BE EF	03	06 00	C4 D0	06 00	09 70	00 00	
eClarity	Get	BE EF	03	06 00	5D 70	02 00	0C 22	00 00	
	Increment	BE EF	03	06 00	3B 70	04 00	0C 22	00 00	
	Decrement	BE EF	03	06 00	EA 71	05 00	0C 22	00 00	
eClarity Reset	Execute	BE EF	03	06 00	C8 DB	06 00	2C 70	00 00	
HDCR	Get	BE EF	03	06 00	A1 71	02 00	0D 22	00 00	
	Increment	BE EF	03	06 00	C7 71	04 00	0D 22	00 00	
	Decrement	BE EF	03	06 00	16 70	05 00	0D 22	00 00	
HDCR Reset	Execute	BE EF	03	06 00	34 DA	06 00	2D 70	00 00	
DYNAMIC IRIS	Set	OFF	BE EF	03	06 00	0B 22	01 00	04 33	00 00
		THEATER	BE EF	03	06 00	CB 2F	01 00	04 33	10 00
		PRESENTATION	BE EF	03	06 00	5B 2E	01 00	04 33	11 00
	Get	BE EF	03	06 00	38 22	02 00	04 33	00 00	
MY MEMORY Load	Set	1	BE EF	03	06 00	0E D7	01 00	14 20	00 00
		2	BE EF	03	06 00	9E D6	01 00	14 20	01 00
		3	BE EF	03	06 00	6E D6	01 00	14 20	02 00
		4	BE EF	03	06 00	FE D7	01 00	14 20	03 00
MY MEMORY Save	Set	1	BE EF	03	06 00	F2 D6	01 00	15 20	00 00
		2	BE EF	03	06 00	62 D7	01 00	15 20	01 00
		3	BE EF	03	06 00	92 D7	01 00	15 20	02 00
		4	BE EF	03	06 00	02 D6	01 00	15 20	03 00
ASPECT	Set	NORMAL	BE EF	03	06 00	5E DD	01 00	08 20	10 00
		4:3	BE EF	03	06 00	9E D0	01 00	08 20	00 00
		16:9	BE EF	03	06 00	0E D1	01 00	08 20	01 00
		16:10	BE EF	03	06 00	3E D6	01 00	08 20	0A 00
		14:9	BE EF	03	06 00	CE D6	01 00	08 20	09 00
	NATIVE *	BE EF	03	06 00	5E D7	01 00	08 20	08 00	
Get	BE EF	03	06 00	AD D0	02 00	08 20	00 00		
OVER SCAN	Get	BE EF	03	06 00	91 70	02 00	09 22	00 00	
	Increment	BE EF	03	06 00	F7 70	04 00	09 22	00 00	
	Decrement	BE EF	03	06 00	26 71	05 00	09 22	00 00	
OVER SCAN Reset	Execute	BE EF	03	06 00	EC D9	06 00	27 70	00 00	
V POSITION	Get	BE EF	03	06 00	0D 83	02 00	00 21	00 00	
	Increment	BE EF	03	06 00	6B 83	04 00	00 21	00 00	
	Decrement	BE EF	03	06 00	BA 82	05 00	00 21	00 00	
V POSITION Reset	Execute	BE EF	03	06 00	E0 D2	06 00	02 70	00 00	

(*) only for LWU601i/LWX651i/LWU701i/LWX751i

Names	Operation Type	Header			CRC	Command Data			
						Action	Type	Setting code	
H POSITION	Get	BE EF	03	06 00	F1 82	02 00	01 21	00 00	
	Increment	BE EF	03	06 00	97 82	04 00	01 21	00 00	
	Decrement	BE EF	03	06 00	46 83	05 00	01 21	00 00	
H POSITION Reset	Execute	BE EF	03	06 00	1C D3	06 00	03 70	00 00	
H PHASE	Get	BE EF	03	06 00	49 83	02 00	03 21	00 00	
	Increment	BE EF	03	06 00	2F 83	04 00	03 21	00 00	
	Decrement	BE EF	03	06 00	FE 82	05 00	03 21	00 00	
H SIZE	Get	BE EF	03	06 00	B5 82	02 00	02 21	00 00	
	Increment	BE EF	03	06 00	D3 82	04 00	02 21	00 00	
	Decrement	BE EF	03	06 00	02 83	05 00	02 21	00 00	
H SIZE Reset	Execute	BE EF	03	06 00	68 D2	06 00	04 70	00 00	
AUTO IMAGE	Execute	BE EF	03	06 00	91 D0	06 00	0A 20	00 00	
PROGRESSIVE	Set	OFF	BE EF	03	06 00	4A 72	01 00	07 22	00 00
		TV	BE EF	03	06 00	DA 73	01 00	07 22	01 00
		FILM	BE EF	03	06 00	2A 73	01 00	07 22	02 00
	Get	BE EF	03	06 00	79 72	02 00	07 22	00 00	
VIDEO NR	Set	LOW	BE EF	03	06 00	26 72	01 00	06 22	01 00
		MID	BE EF	03	06 00	D6 72	01 00	06 22	02 00
		HIGH	BE EF	03	06 00	46 73	01 00	06 22	03 00
	Get	BE EF	03	06 00	85 73	02 00	06 22	00 00	
COLOR SPACE	Set	AUTO	BE EF	03	06 00	0E 72	01 00	04 22	00 00
		RGB	BE EF	03	06 00	9E 73	01 00	04 22	01 00
		SMPTE240	BE EF	03	06 00	6E 73	01 00	04 22	02 00
		REC709	BE EF	03	06 00	FE 72	01 00	04 22	03 00
	REC601	BE EF	03	06 00	CE 70	01 00	04 22	04 00	
Get	BE EF	03	06 00	3D 72	02 00	04 22	00 00		
C-VIDEO FORMAT	Set	AUTO	BE EF	03	06 00	A2 70	01 00	11 22	0A 00
		NTSC	BE EF	03	06 00	C2 74	01 00	11 22	04 00
		PAL	BE EF	03	06 00	52 75	01 00	11 22	05 00
		SECAM	BE EF	03	06 00	52 70	01 00	11 22	09 00
		NTSC4.43	BE EF	03	06 00	62 77	01 00	11 22	02 00
		M-PAL	BE EF	03	06 00	C2 71	01 00	11 22	08 00
	N-PAL	BE EF	03	06 00	32 74	01 00	11 22	07 00	
Get	BE EF	03	06 00	31 76	02 00	11 22	00 00		
HDMI 1 FORMAT	Set	AUTO	BE EF	03	06 00	BA 77	01 00	13 22	00 00
		VIDEO	BE EF	03	06 00	2A 76	01 00	13 22	01 00
		COMPUTER	BE EF	03	06 00	DA 76	01 00	13 22	02 00
	Get	BE EF	03	06 00	89 77	02 00	13 22	00 00	
HDMI 2 FORMAT	Set	AUTO	BE EF	03	06 00	52 75	01 00	1D 22	00 00
		VIDEO	BE EF	03	06 00	C2 74	01 00	1D 22	01 00
		COMPUTER	BE EF	03	06 00	32 74	01 00	1D 22	02 00
	Get	BE EF	03	06 00	61 75	02 00	1D 22	00 00	

RS-232C Communication / Network command table (continued)

Names	Operation Type	Header				CRC	Command Data		
							Action	Type	Setting code
HDBaseT FORMAT	Set	AUTO	BE EF	03	06 00	7A EA	01 00	D3 20	00 00
		VIDEO	BE EF	03	06 00	EA EB	01 00	D3 20	01 00
		COMPUTER	BE EF	03	06 00	1A EB	01 00	D3 20	02 00
	Get	BE EF	03	06 00	49 EA	02 00	D3 20	00 00	
DisplayPort FORMAT	Set	AUTO	BE EF	03	06 00	BA E1	01 00	F3 20	00 00
		VIDEO	BE EF	03	06 00	2A E0	01 00	F3 20	01 00
		COMPUTER	BE EF	03	06 00	DA E0	01 00	F3 20	02 00
	Get	BE EF	03	06 00	89 E1	02 00	F3 20	00 00	
HDMI 1 RANGE	Set	AUTO	BE EF	03	06 00	86 D8	01 00	22 20	00 00
		NORMAL	BE EF	03	06 00	16 D9	01 00	22 20	01 00
		ENHANCED	BE EF	03	06 00	E6 D9	01 00	22 20	02 00
	Get	BE EF	03	06 00	B5 D8	02 00	22 20	00 00	
HDMI 2 RANGE	Set	AUTO	BE EF	03	06 00	7A D9	01 00	23 20	00 00
		NORMAL	BE EF	03	06 00	EA D8	01 00	23 20	01 00
		ENHANCED	BE EF	03	06 00	1A D8	01 00	23 20	02 00
	Get	BE EF	03	06 00	49 D9	02 00	23 20	00 00	
HDBaseT RANGE	Set	AUTO	BE EF	03	06 00	86 EB	01 00	D2 20	00 00
		NORMAL	BE EF	03	06 00	16 EA	01 00	D2 20	01 00
		ENHANCED	BE EF	03	06 00	E6 EA	01 00	D2 20	02 00
	Get	BE EF	03	06 00	B5 EB	02 00	D2 20	00 00	
SDI RANGE*	Set	NORMAL	BE EF	03	06 00	16 E5	01 00	E2 20	01 00
		ENHANCED	BE EF	03	06 00	E6 E5	01 00	E2 20	02 00
	Get	BE EF	03	06 00	B5 E4	02 00	E2 20	00 00	
DisplayPort RANGE	Set	AUTO	BE EF	03	06 00	46 E0	01 00	F2 20	00 00
		NORMAL	BE EF	03	06 00	D6 E1	01 00	F2 20	01 00
		ENHANCED	BE EF	03	06 00	26 E1	01 00	F2 20	02 00
	Get	BE EF	03	06 00	75 E0	02 00	F2 20	00 00	
COMPUTER IN	Set	AUTO	BE EF	03	06 00	CE D6	01 00	10 20	03 00
		SYNC ON G OFF	BE EF	03	06 00	5E D7	01 00	10 20	02 00
	Get	BE EF	03	06 00	0D D6	02 00	10 20	00 00	
FRAME LOCK - COMPUTER IN	Set	OFF	BE EF	03	06 00	3B C2	01 00	50 30	00 00
		ON	BE EF	03	06 00	AB C3	01 00	50 30	01 00
	Get	BE EF	03	06 00	08 C2	02 00	50 30	00 00	
FRAME LOCK - HDMI 1	Set	OFF	BE EF	03	06 00	7F C2	01 00	53 30	00 00
		ON	BE EF	03	06 00	EF C3	01 00	53 30	01 00
	Get	BE EF	03	06 00	4C C2	02 00	53 30	00 00	
FRAME LOCK - HDMI 2	Set	OFF	BE EF	03	06 00	97 C0	01 00	5D 30	00 00
		ON	BE EF	03	06 00	07 C1	01 00	5D 30	01 00
	Get	BE EF	03	06 00	A4 C0	02 00	5D 30	00 00	
FRAME LOCK - HDBaseT	Set	OFF	BE EF	03	06 00	C2 EB	01 00	D1 20	00 00
		ON	BE EF	03	06 00	52 EA	01 00	D1 20	01 00
	Get	BE EF	03	06 00	F1 EB	02 00	D1 20	00 00	

* Supported only for LWU701i

Names	Operation Type	Header				CRC	Command Data		
							Action	Type	Setting code
FRAME LOCK - SDI*	Set	OFF	BE EF	03	06 00	C2 E4	01 00	E1 20	00 00
		ON	BE EF	03	06 00	52 E5	01 00	E1 20	01 00
	Get	BE EF	03	06 00	F1 E4	02 00	E1 20	00 00	
FRAME LOCK - DisplayPort	Set	OFF	BE EF	03	06 00	02 E0	01 00	F1 20	00 00
		ON	BE EF	03	06 00	92 E1	01 00	F1 20	01 00
	Get	BE EF	03	06 00	31 E0	02 00	F1 20	00 00	
PICTURE POSITION V	Set	TOP	BE EF	03	06 00	02 D0	01 00	09 20	02 00
		MIDDLE	BE EF	03	06 00	62 D1	01 00	09 20	00 00
		BOTTOM	BE EF	03	06 00	F2 D0	01 00	09 20	01 00
	Get	BE EF	03	06 00	51 D1	02 00	09 20	00 00	
PICTURE POSITION H	Set	RIGHT	BE EF	03	06 00	46 D5	01 00	1E 20	01 00
		MIDDLE	BE EF	03	06 00	D6 D4	01 00	1E 20	00 00
		LEFT	BE EF	03	06 00	B6 D5	01 00	1E 20	02 00
	Get	BE EF	03	06 00	E5 D4	02 00	1E 20	00 00	
GEOMETRIC MODE	Set	KEYSTONE	BE EF	03	06 00	6B 8C	01 00	30 31	01 00
		3D KEYSTONE	BE EF	03	06 00	9B 8C	01 00	30 31	02 00
		WARPING	BE EF	03	06 00	3B 8F	01 00	30 31	04 00
	Get	BE EF	03	06 00	C8 8D	02 00	30 31	00 00	
KEYSTONE V	Get	BE EF	03	06 00	B9 D3	02 00	07 20	00 00	
	Increment	BE EF	03	06 00	DF D3	04 00	07 20	00 00	
	Decrement	BE EF	03	06 00	0E D2	05 00	07 20	00 00	
KEYSTONE V Reset	Execute	BE EF	03	06 00	08 D0	06 00	0C 70	00 00	
KEYSTONE H	Get	BE EF	03	06 00	E9 D0	02 00	0B 20	00 00	
	Increment	BE EF	03	06 00	8F D0	04 00	0B 20	00 00	
	Decrement	BE EF	03	06 00	5E D1	05 00	0B 20	00 00	
KEYSTONE H Reset	Execute	BE EF	03	06 00	98 D8	06 00	20 70	00 00	
3D KEYSTONE Left Top - H	Get	BE EF	03	06 00	31 89	02 00	21 21	00 00	
	Increment	BE EF	03	06 00	57 89	04 00	21 21	00 00	
	Decrement	BE EF	03	06 00	86 88	05 00	21 21	00 00	
3D KEYSTONE Left Top - V	Get	BE EF	03	06 00	75 89	02 00	22 21	00 00	
	Increment	BE EF	03	06 00	13 89	04 00	22 21	00 00	
	Decrement	BE EF	03	06 00	C2 88	05 00	22 21	00 00	
3D KEYSTONE Right Top - H	Get	BE EF	03	06 00	89 88	02 00	23 21	00 00	
	Increment	BE EF	03	06 00	EF 88	04 00	23 21	00 00	
	Decrement	BE EF	03	06 00	3E 89	05 00	23 21	00 00	
3D KEYSTONE Right Top - V	Get	BE EF	03	06 00	FD 89	02 00	24 21	00 00	
	Increment	BE EF	03	06 00	9B 89	04 00	24 21	00 00	
	Decrement	BE EF	03	06 00	4A 88	05 00	24 21	00 00	

* Supported only for LWU701i

Names	Operation Type	Header			CRC	Command Data		
						Action	Type	Setting code
3D KEYSTONE Left Bottom - H	Get	BE EF	03	06 00	01 88	02 00	25 21	00 00
	Increment	BE EF	03	06 00	67 88	04 00	25 21	00 00
	Decrement	BE EF	03	06 00	B6 89	05 00	25 21	00 00
3D KEYSTONE Left Bottom - V	Get	BE EF	03	06 00	45 88	02 00	26 21	00 00
	Increment	BE EF	03	06 00	23 88	04 00	26 21	00 00
	Decrement	BE EF	03	06 00	F2 89	05 00	26 21	00 00
3D KEYSTONE Right Bottom - H	Get	BE EF	03	06 00	B9 89	02 00	27 21	00 00
	Increment	BE EF	03	06 00	DF 89	04 00	27 21	00 00
	Decrement	BE EF	03	06 00	0E 88	05 00	27 21	00 00
3D KEYSTONE Right Bottom - V	Get	BE EF	03	06 00	AD 8A	02 00	28 21	00 00
	Increment	BE EF	03	06 00	CB 8A	04 00	28 21	00 00
	Decrement	BE EF	03	06 00	1A 8B	05 00	28 21	00 00
3D KEYSTONE All Corners Reset	Execute	BE EF	03	06 00	D5 8A	06 00	29 21	00 00
3D KEYSTONE Left Side Distortion	Get	BE EF	03	06 00	31 97	02 00	41 21	00 00
	Increment	BE EF	03	06 00	57 97	04 00	41 21	00 00
	Decrement	BE EF	03	06 00	86 96	05 00	41 21	00 00
3D KEYSTONE Right Side Distortion	Get	BE EF	03	06 00	75 97	02 00	42 21	00 00
	Increment	BE EF	03	06 00	13 97	04 00	42 21	00 00
	Decrement	BE EF	03	06 00	C2 96	05 00	42 21	00 00
3D KEYSTONE Top Side Distortion	Get	BE EF	03	06 00	FD 97	02 00	44 21	00 00
	Increment	BE EF	03	06 00	9B 97	04 00	44 21	00 00
	Decrement	BE EF	03	06 00	4A 96	05 00	44 21	00 00
3D KEYSTONE Bottom Side Distortion	Get	BE EF	03	06 00	01 96	02 00	45 21	00 00
	Increment	BE EF	03	06 00	67 96	04 00	45 21	00 00
	Decrement	BE EF	03	06 00	B6 97	05 00	45 21	00 00
3D KEYSTONE All Sides Reset	Execute	BE EF	03	06 00	3D 96	06 00	47 21	00 00
3D KEYSTONE Memory Save-1	Execute	BE EF	03	06 00	29 95	06 00	48 21	00 00
3D KEYSTONE Memory Save-2	Execute	BE EF	03	06 00	D5 94	06 00	49 21	00 00
3D KEYSTONE Memory Save-3	Execute	BE EF	03	06 00	91 94	06 00	4A 21	00 00
3D KEYSTONE Memory Load-1	Execute	BE EF	03	06 00	6D 95	06 00	4B 21	00 00
3D KEYSTONE Memory Load-2	Execute	BE EF	03	06 00	19 94	06 00	4C 21	00 00
3D KEYSTONE Memory Load-3	Execute	BE EF	03	06 00	E5 95	06 00	4D 21	00 00

Names	Operation Type	Header			CRC	Command Data			
						Action	Type	Setting code	
EDGE BLENDING MODE	Set	OFF	BE EF	03	06 00	6B 94	01 00	4C 31	00 00
		MANUAL	BE EF	03	06 00	FB 95	01 00	4C 31	01 00
		CAMERA	BE EF	03	06 00	0B 95	01 00	4C 31	02 00
	Get	BE EF	03	06 00	58 94	02 00	4C 31	00 00	
EDGE BLENDING REGION Reset	Execute	BE EF	03	06 00	8C 96	06 00	40 31	00 00	
EDGE BLENDING LEVEL	Increment	BE EF	03	06 00	92 96	04 00	41 31	00 00	
	Decrement	BE EF	03	06 00	43 97	05 00	41 31	00 00	
	Get	BE EF	03	06 00	F4 96	02 00	41 31	00 00	
EDGE BLENDING LEFT	Get	BE EF	03	06 00	68 95	02 00	48 31	00 00	
	Increment	BE EF	03	06 00	0E 95	04 00	48 31	00 00	
	Decrement	BE EF	03	06 00	DF 94	05 00	48 31	00 00	
EDGE BLENDING RIGHT	Get	BE EF	03	06 00	94 94	02 00	49 31	00 00	
	Increment	BE EF	03	06 00	F2 94	04 00	49 31	00 00	
	Decrement	BE EF	03	06 00	23 95	05 00	49 31	00 00	
EDGE BLENDING TOP	Get	BE EF	03	06 00	D0 94	02 00	4A 31	00 00	
	Increment	BE EF	03	06 00	B6 94	04 00	4A 31	00 00	
	Decrement	BE EF	03	06 00	67 95	05 00	4A 31	00 00	
EDGE BLENDING BOTTOM	Get	BE EF	03	06 00	2C 95	02 00	4B 31	00 00	
	Increment	BE EF	03	06 00	4A 95	04 00	4B 31	00 00	
	Decrement	BE EF	03	06 00	9B 94	05 00	4B 31	00 00	

Names	Operation Type	Header				CRC	Command Data		
							Action	Type	Setting code
CROPPING MODE	Set	OFF	BE EF	03	06 00	FB 93	01 00	50 31	00 00
		ON	BE EF	03	06 00	6B 92	01 00	50 31	01 00
	Get	BE EF	03	06 00	C8 93	02 00	50 31	00 00	
CROPPING SETUP X	Get	BE EF	03	06 00	A8 91	02 00	58 31	00 00	
	Increment	BE EF	03	06 00	CE 91	04 00	58 31	00 00	
	Decrement	BE EF	03	06 00	1F 90	05 00	58 31	00 00	
CROPPING SETUP Y	Get	BE EF	03	06 00	54 90	02 00	59 31	00 00	
	Increment	BE EF	03	06 00	32 90	04 00	59 31	00 00	
	Decrement	BE EF	03	06 00	E3 91	05 00	59 31	00 00	
CROPPING SETUP W	Get	BE EF	03	06 00	10 90	02 00	5A 31	00 00	
	Increment	BE EF	03	06 00	76 90	04 00	5A 31	00 00	
	Decrement	BE EF	03	06 00	A7 91	05 00	5A 31	00 00	
CROPPING SETUP H	Get	BE EF	03	06 00	EC 91	02 00	5B 31	00 00	
	Increment	BE EF	03	06 00	8A 91	04 00	5B 31	00 00	
	Decrement	BE EF	03	06 00	5B 90	05 00	5B 31	00 00	
CROPPING Apply	Execute	BE EF	03	06 00	B0 93	06 00	51 31	00 00	
CROPPING Reset	Execute	BE EF	03	06 00	F4 93	06 00	52 31	00 00	
WARPING MODE	Set	OFF	BE EF	03	06 00	FB 9C	01 00	60 31	00 00
		MODE-1	BE EF	03	06 00	6B 9D	01 00	60 31	01 00
		MODE-2	BE EF	03	06 00	9B 9D	01 00	60 31	02 00
		MODE-3	BE EF	03	06 00	0B 9C	01 00	60 31	03 00
	Get	BE EF	03	06 00	C8 9C	02 00	60 31	00 00	
Dimming Level	Get	BE EF	03	06 00	7C 22	02 00	07 33	00 00	
	Increment	BE EF	03	06 00	1A 22	04 00	07 33	00 00	
	Decrement	BE EF	03	06 00	CB 23	05 00	07 33	00 00	
WHITE BALANCE OFFSET R	Get	BE EF	03	06 00	0C 72	02 00	50 27	00 00	
	Increment	BE EF	03	06 00	6A 72	04 00	50 27	00 00	
	Decrement	BE EF	03	06 00	BB 73	05 00	50 27	00 00	
WHITE BALANCE OFFSET R Reset	Execute	BE EF	03	06 00	38 E2	06 00	F8 70	00 00	
WHITE BALANCE OFFSET G	Get	BE EF	03	06 00	F0 73	02 00	51 27	00 00	
	Increment	BE EF	03	06 00	96 73	04 00	51 27	00 00	
	Decrement	BE EF	03	06 00	47 72	05 00	51 27	00 00	
WHITE BALANCE OFFSET G RReset	Execute	BE EF	03	06 00	C4 E3	06 00	F9 70	00 00	
WHITE BALANCE OFFSET B	Get	BE EF	03	06 00	B4 73	02 00	52 27	00 00	
	Increment	BE EF	03	06 00	D2 73	04 00	52 27	00 00	
	Decrement	BE EF	03	06 00	03 72	05 00	52 27	00 00	
WHITE BALANCE OFFSET B Reset	Execute	BE EF	03	06 00	80 E3	06 00	FA 70	00 00	

Names	Operation Type	Header			CRC	Command Data		
						Action	Type	Setting code
WHITE BALANCE GAIN R	Get	BE EF	03	06 00	3C 73	02 00	54 27	00 00
	Increment	BE EF	03	06 00	5A 73	04 00	54 27	00 00
	Decrement	BE EF	03	06 00	8B 72	05 00	54 27	00 00
WHITE BALANCE GAIN R Reset	Execute	BE EF	03	06 00	08 E3	06 00	FC 70	00 00
WHITE BALANCE GAIN G	Get	BE EF	03	06 00	C0 72	02 00	55 27	00 00
	Increment	BE EF	03	06 00	A6 72	04 00	55 27	00 00
	Decrement	BE EF	03	06 00	77 73	05 00	55 27	00 00
WHITE BALANCE GAIN G Reset	Execute	BE EF	03	06 00	F4 E2	06 00	FD 70	00 00
WHITE BALANCE GAIN B	Get	BE EF	03	06 00	84 72	02 00	56 27	00 00
	Increment	BE EF	03	06 00	E2 72	04 00	56 27	00 00
	Decrement	BE EF	03	06 00	33 73	05 00	56 27	00 00
WHITE BALANCE GAIN B Reset	Execute	BE EF	03	06 00	B0 E2	06 00	FE 70	00 00
BLACK LEVEL R	Get	BE EF	03	06 00	CC 76	02 00	40 27	00 00
	Increment	BE EF	03	06 00	AA 76	04 00	40 27	00 00
	Decrement	BE EF	03	06 00	7B 77	05 00	40 27	00 00
BLACK LEVEL R Reset	Execute	BE EF	03	06 00	68 E1	06 00	F4 70	00 00
BLACK LEVEL G	Get	BE EF	03	06 00	30 77	02 00	41 27	00 00
	Increment	BE EF	03	06 00	56 77	04 00	41 27	00 00
	Decrement	BE EF	03	06 00	87 76	05 00	41 27	00 00
BLACK LEVEL G Reset	Execute	BE EF	03	06 00	94 E0	06 00	F5 70	00 00
BLACK LEVEL B	Get	BE EF	03	06 00	74 77	02 00	42 27	00 00
	Increment	BE EF	03	06 00	12 77	04 00	42 27	00 00
	Decrement	BE EF	03	06 00	C3 76	05 00	42 27	00 00
BLACK LEVEL B Reset	Execute	BE EF	03	06 00	D0 E0	06 00	F6 70	00 00
BLACK LEVEL W	Get	BE EF	03	06 00	88 76	02 00	43 27	00 00
	Increment	BE EF	03	06 00	EE 76	04 00	43 27	00 00
	Decrement	BE EF	03	06 00	3F 77	05 00	43 27	00 00
BLACK LEVEL W Reset	Execute	BE EF	03	06 00	2C E1	06 00	F7 70	00 00

Names	Operation Type	Header			CRC	Command Data			
						Action	Type	Setting code	
HDCR LiteLoc	Set	OFF	BE EF	03	06 00	D6 71	01 00	0E 22	00 00
		ON	BE EF	03	06 00	46 70	01 00	0E 22	01 00
	Get	BE EF	03	06 00	E5 71	02 00	0E 22	00 00	
ECO MODE	Set	NORMAL	BE EF	03	06 00	3B 23	01 00	00 33	00 00
		ECO	BE EF	03	06 00	AB 22	01 00	00 33	01 00
	Get	BE EF	03	06 00	08 23	02 00	00 33	00 00	
INSTALLATION	Set	FRONT / DESKTOP	BE EF	03	06 00	C7 D2	01 00	01 30	00 00
		REAR / DESKTOP	BE EF	03	06 00	57 D3	01 00	01 30	01 00
		REAR / CEILING	BE EF	03	06 00	A7 D3	01 00	01 30	02 00
		FRONT / CEILING	BE EF	03	06 00	37 D2	01 00	01 30	03 00
	Get	BE EF	03	06 00	F4 D2	02 00	01 30	00 00	
STANDBY MODE	Set	NORMAL	BE EF	03	06 00	D6 D2	01 00	01 60	00 00
		POWER SAVE	BE EF	03	06 00	46 D3	01 00	01 60	01 00
	Get	BE EF	03	06 00	E5 D2	02 00	01 60	00 00	
COLOR UNIFORMITY LEVEL	Set	1	BE EF	03	06 00	AF 6D	01 00	30 27	01 00
		2	BE EF	03	06 00	5F 6D	01 00	30 27	02 00
		3	BE EF	03	06 00	CF 6C	01 00	30 27	03 00
		4	BE EF	03	06 00	FF 6E	01 00	30 27	04 00
	Get	BE EF	03	06 00	0C 6C	02 00	30 27	00 00	
COLOR UNIFORMITY AREA	Set	Top Left	BE EF	03	06 00	C3 6D	01 00	31 27	00 00
		Top	BE EF	03	06 00	53 6C	01 00	31 27	01 00
		Top Right	BE EF	03	06 00	A3 6C	01 00	31 27	02 00
		Left	BE EF	03	06 00	03 AC	01 00	31 27	00 01
		All	BE EF	03	06 00	93 AD	01 00	31 27	01 01
		Right	BE EF	03	06 00	63 AD	01 00	31 27	02 01
		Bottom Left	BE EF	03	06 00	02 EC	01 00	31 27	00 02
		Bottom	BE EF	03	06 00	92 ED	01 00	31 27	01 02
	Bottom Right	BE EF	03	06 00	62 ED	01 00	31 27	02 02	
Get	BE EF	03	06 00	F0 6D	02 00	31 27	00 00		
COLOR UNIFORMITY R	Get	BE EF	03	06 00	B4 6D	02 00	32 27	00 00	
	Increment	BE EF	03	06 00	D2 6D	04 00	32 27	00 00	
	Decrement	BE EF	03	06 00	03 6C	05 00	32 27	00 00	
COLOR UNIFORMITY R Reset	Execute	BE EF	03	06 00	58 E0	06 00	F0 70	00 00	
COLOR UNIFORMITY G	Get	BE EF	03	06 00	48 6C	02 00	33 27	00 00	
	Increment	BE EF	03	06 00	2E 6C	04 00	33 27	00 00	
	Decrement	BE EF	03	06 00	FF 6D	05 00	33 27	00 00	
COLOR UNIFORMITY G Reset	Execute	BE EF	03	06 00	A4 E1	06 00	F1 70	00 00	
COLOR UNIFORMITY B	Get	BE EF	03	06 00	3C 6D	02 00	34 27	00 00	
	Increment	BE EF	03	06 00	5A 6D	04 00	34 27	00 00	
	Decrement	BE EF	03	06 00	8B 6C	05 00	34 27	00 00	
COLOR UNIFORMITY B Reset	Execute	BE EF	03	06 00	E0 E1	06 00	F2 70	00 00	

Names	Operation Type	Header			CRC	Command Data			
						Action	Type	Setting code	
COLOR UNIFORMITY ALL Reset	Execute	BE EF	03	06 00	1C E0	06 00	F3 70	00 00	
COLOR UNIFORMITY PATTERN	Set	OFF	BE EF	03	06 00	B7 6C	01 00	36 27	00 00
		ON	BE EF	03	06 00	27 6D	01 00	36 27	01 00
	Get	BE EF	03	06 00	84 6C	02 00	36 27	00 00	
VOLUME - COMPUTER IN	Get	BE EF	03	06 00	CD CC	02 00	60 20	00 00	
	Increment	BE EF	03	06 00	AB CC	04 00	60 20	00 00	
	Decrement	BE EF	03	06 00	7A CD	05 00	60 20	00 00	
VOLUME - LAN	Get	BE EF	03	06 00	E9 CE	02 00	6B 20	00 00	
	Increment	BE EF	03	06 00	8F CE	04 00	6B 20	00 00	
	Decrement	BE EF	03	06 00	5E CF	05 00	6B 20	00 00	
VOLUME - HDMI 1	Get	BE EF	03	06 00	89 CC	02 00	63 20	00 00	
	Increment	BE EF	03	06 00	EF CC	04 00	63 20	00 00	
	Decrement	BE EF	03	06 00	3E CD	05 00	63 20	00 00	
VOLUME - HDMI 2	Get	BE EF	03	06 00	61 CE	02 00	6D 20	00 00	
	Increment	BE EF	03	06 00	07 CE	04 00	6D 20	00 00	
	Decrement	BE EF	03	06 00	D6 CF	05 00	6D 20	00 00	
VOLUME - HDBaseT	Get	BE EF	03	06 00	C1 EA	02 00	D5 20	00 00	
	Increment	BE EF	03	06 00	A7 EA	04 00	D5 20	00 00	
	Decrement	BE EF	03	06 00	76 EB	05 00	D5 20	00 00	
VOLUME - VIDEO	Get	BE EF	03	06 00	31 CD	02 00	61 20	00 00	
	Increment	BE EF	03	06 00	57 CD	04 00	61 20	00 00	
	Decrement	BE EF	03	06 00	86 CC	05 00	61 20	00 00	
VOLUME - SDI*	Get	BE EF	03	06 00	C1 E5	02 00	E5 20	00 00	
	Increment	BE EF	03	06 00	A7 E5	04 00	E5 20	00 00	
	Decrement	BE EF	03	06 00	76 E4	05 00	E5 20	00 00	
VOLUME - DisplayPort	Get	BE EF	03	06 00	01 E1	02 00	F5 20	00 00	
	Increment	BE EF	03	06 00	67 E1	04 00	F5 20	00 00	
	Decrement	BE EF	03	06 00	B6 E0	05 00	F5 20	00 00	
VOLUME - STANDBY	Get	BE EF	03	06 00	D9 CF	02 00	6F 20	00 00	
	Increment	BE EF	03	06 00	BF CF	04 00	6F 20	00 00	
	Decrement	BE EF	03	06 00	6E CE	05 00	6F 20	00 00	
VOLUME - ALL	Get	BE EF	03	06 00	CD C3	02 00	50 20	00 00	
	Increment	BE EF	03	06 00	AB C3	04 00	50 20	00 00	
	Decrement	BE EF	03	06 00	7A C2	05 00	50 20	00 00	
MUTE	Set	OFF	BE EF	03	06 00	46 D3	01 00	02 20	00 00
		ON	BE EF	03	06 00	D6 D2	01 00	02 20	01 00
	Get	BE EF	03	06 00	75 D3	02 00	02 20	00 00	
AV MUTE	Set	OFF	BE EF	03	06 00	FE F0	01 00	A0 20	00 00
		ON	BE EF	03	06 00	6E F1	01 00	A0 20	01 00
	Get	BE EF	03	06 00	CD F0	02 00	A0 20	00 00	
SPEAKER	Set	OFF	BE EF	03	06 00	6E D5	01 00	1C 20	00 00
		ON	BE EF	03	06 00	FE D4	01 00	1C 20	01 00
	Get	BE EF	03	06 00	5D D5	02 00	1C 20	00 00	

* Supported only for LWU701i

Names	Operation Type	Header				CRC	Command Data		
							Action	Type	Setting code
AUDIO SOURCE - COMPUTER IN	Set	AUDIO IN1	BE EF	03	06 00	6E DC	01 00	30 20	01 00
		AUDIO IN2	BE EF	03	06 00	9E DC	01 00	30 20	02 00
		OFF	BE EF	03	06 00	FE DD	01 00	30 20	00 00
		Get	BE EF	03	06 00	CD DD	02 00	30 20	00 00
	AUDIO SOURCE - LAN	Set	AUDIO IN1	BE EF	03	06 00	4A DE	01 00	3B 20
AUDIO IN2	BE EF		03	06 00	BA DE	01 00	3B 20	02 00	
AUDIO LAN	BE EF		03	06 00	8A D3	01 00	3B 20	11 00	
OFF	BE EF		03	06 00	DA DF	01 00	3B 20	00 00	
Get	BE EF		03	06 00	E9 DF	02 00	3B 20	00 00	
AUDIO SOURCE - HDMI 1	Set	AUDIO IN1	BE EF	03	06 00	2A DC	01 00	33 20	01 00
		AUDIO IN2	BE EF	03	06 00	DA DC	01 00	33 20	02 00
		AUDIO HDMI 1	BE EF	03	06 00	7A C4	01 00	33 20	20 00
		OFF	BE EF	03	06 00	BA DD	01 00	33 20	00 00
	Get	BE EF	03	06 00	89 DD	02 00	33 20	00 00	
AUDIO SOURCE - HDMI 2	Set	AUDIO IN1	BE EF	03	06 00	C2 DE	01 00	3D 20	01 00
		AUDIO IN2	BE EF	03	06 00	32 DE	01 00	3D 20	02 00
		AUDIO HDMI 2	BE EF	03	06 00	02 C7	01 00	3D 20	21 00
		OFF	BE EF	03	06 00	52 DF	01 00	3D 20	00 00
	Get	BE EF	03	06 00	61 DF	02 00	3D 20	00 00	
AUDIO SOURCE - HDBaseT	Set	AUDIO IN1	BE EF	03	06 00	9E EA	01 00	D4 20	01 00
		AUDIO IN2	BE EF	03	06 00	6E EA	01 00	D4 20	02 00
		AUDIO HDBaseT	BE EF	03	06 00	0E F0	01 00	D4 20	24 00
		OFF	BE EF	03	06 00	0E EB	01 00	D4 20	00 00
	Get	BE EF	03	06 00	3D EB	02 00	D4 20	00 00	
AUDIO SOURCE - SDI*	Set	AUDIO IN1	BE EF	03	06 00	9E E5	01 00	E4 20	01 00
		AUDIO IN2	BE EF	03	06 00	6E E5	01 00	E4 20	02 00
		OFF	BE EF	03	06 00	0E E4	01 00	E4 20	00 00
	Get	BE EF	03	06 00	3D E4	02 00	E4 20	00 00	
AUDIO SOURCE - DisplayPort	Set	AUDIO IN1	BE EF	03	06 00	5E E1	01 00	F4 20	01 00
		AUDIO IN2	BE EF	03	06 00	AE E1	01 00	F4 20	02 00
		AUDIO DisplayPort	BE EF	03	06 00	AE FA	01 00	F4 20	26 00
		OFF	BE EF	03	06 00	CE E0	01 00	F4 20	00 00
	Get	BE EF	03	06 00	FD E0	02 00	F4 20	00 00	

* Supported only for LWU701i

Names	Operation Type	Header				CRC	Command Data		
							Action	Type	Setting code
AUDIO SOURCE - VIDEO	Set	AUDIO IN1	BE EF	03	06 00	92 DD	01 00	31 20	01 00
		AUDIO IN2	BE EF	03	06 00	62 DD	01 00	31 20	02 00
		OFF	BE EF	03	06 00	02 DC	01 00	31 20	00 00
	Get	BE EF	03	06 00	31 DC	02 00	31 20	00 00	
AUDIO SOURCE - AUDIO OUT STANDBY	Set	AUDIO IN1	BE EF	03	06 00	7A DF	01 00	3F 20	01 00
		AUDIO IN2	BE EF	03	06 00	8A DF	01 00	3F 20	02 00
		HDMI 1	BE EF	03	06 00	2A C7	01 00	3F 20	20 00
		HDMI 2	BE EF	03	06 00	BA C6	01 00	3F 20	21 00
		HDBaseT	BE EF	03	06 00	EA C5	01 00	3F 20	24 00
		DisplayPort	BE EF	03	06 00	8A C4	01 00	3F 20	26 00
	OFF	BE EF	03	06 00	EA DE	01 00	3F 20	00 00	
Get	BE EF	03	06 00	D9 DE	02 00	3F 20	00 00		
LAN SOUND ENABLE	Set	Disable	BE EF	03	06 00	BA F0	01 00	A3 20	00 00
		Enable	BE EF	03	06 00	2A F1	01 00	A3 20	01 00
	Get	BE EF	03	06 00	89 F0	02 00	A3 20	00 00	
LANGUAGE	Set	ENGLISH	BE EF	03	06 00	F7 D3	01 00	05 30	00 00
		FRANÇAIS	BE EF	03	06 00	67 D2	01 00	05 30	01 00
		DEUTSCH	BE EF	03	06 00	97 D2	01 00	05 30	02 00
		ESPAÑOL	BE EF	03	06 00	07 D3	01 00	05 30	03 00
		ITALIANO	BE EF	03	06 00	37 D1	01 00	05 30	04 00
		NORSK	BE EF	03	06 00	A7 D0	01 00	05 30	05 00
		NEDERLANDS	BE EF	03	06 00	57 D0	01 00	05 30	06 00
		PORTUGUÊS	BE EF	03	06 00	C7 D1	01 00	05 30	07 00
		日本語	BE EF	03	06 00	37 D4	01 00	05 30	08 00
		簡体中文	BE EF	03	06 00	A7 D5	01 00	05 30	09 00
		繁体中文	BE EF	03	06 00	37 DE	01 00	05 30	10 00
		한국어	BE EF	03	06 00	57 D5	01 00	05 30	0A 00
		SVENSKA	BE EF	03	06 00	C7 D4	01 00	05 30	0B 00
		РУССКИЙ	BE EF	03	06 00	F7 D6	01 00	05 30	0C 00
		SUOMI	BE EF	03	06 00	67 D7	01 00	05 30	0D 00
	POLSKI	BE EF	03	06 00	97 D7	01 00	05 30	0E 00	
TÜRKÇE	BE EF	03	06 00	07 D6	01 00	05 30	0F 00		
Get	BE EF	03	06 00	C4 D3	02 00	05 30	00 00		

Names	Operation Type	Header			CRC	Command Data			
						Action	Type	Setting code	
MENU POSITION V	Get	BE EF	03	06 00	40 D7	02 00	16 30	00 00	
	Increment	BE EF	03	06 00	26 D7	04 00	16 30	00 00	
	Decrement	BE EF	03	06 00	F7 D6	05 00	16 30	00 00	
MENU POSITION V Reset	Execute	BE EF	03	06 00	A8 C7	06 00	44 70	00 00	
MENU POSITION H	Get	BE EF	03	06 00	04 D7	02 00	15 30	00 00	
	Increment	BE EF	03	06 00	62 D7	04 00	15 30	00 00	
	Decrement	BE EF	03	06 00	B3 D6	05 00	15 30	00 00	
MENU POSITION H Reset	Execute	BE EF	03	06 00	DC C6	06 00	43 70	00 00	
BLANK	Set	My Screen	BE EF	03	06 00	FB CA	01 00	00 30	20 00
		ORIGINAL	BE EF	03	06 00	FB E2	01 00	00 30	40 00
		BLUE	BE EF	03	06 00	CB D3	01 00	00 30	03 00
		WHITE	BE EF	03	06 00	6B D0	01 00	00 30	05 00
		BLACK	BE EF	03	06 00	9B D0	01 00	00 30	06 00
	Get	BE EF	03	06 00	08 D3	02 00	00 30	00 00	
BLANK On/Off	Set	OFF	BE EF	03	06 00	FB D8	01 00	20 30	00 00
		ON	BE EF	03	06 00	6B D9	01 00	20 30	01 00
	Get	BE EF	03	06 00	C8 D8	02 00	20 30	00 00	
AUTO BLANK	Set	BLUE	BE EF	03	06 00	67 D1	01 00	0D 30	03 00
		WHITE	BE EF	03	06 00	C7 D2	01 00	0D 30	05 00
		BLACK	BE EF	03	06 00	37 D2	01 00	0D 30	06 00
	Get	BE EF	03	06 00	A4 D1	02 00	0D 30	00 00	
START UP	Set	My Screen	BE EF	03	06 00	CB CB	01 00	04 30	20 00
		ORIGINAL	BE EF	03	06 00	0B D2	01 00	04 30	00 00
		OFF	BE EF	03	06 00	9B D3	01 00	04 30	01 00
	Get	BE EF	03	06 00	38 D2	02 00	04 30	00 00	

Names	Operation Type	Header				CRC	Command Data		
							Action	Type	Setting code
My Screen Lock	Set	OFF	BE EF	03	06 00	3B EF	01 00	C0 30	00 00
		ON	BE EF	03	06 00	AB EE	01 00	C0 30	01 00
	Get	BE EF	03	06 00	08 EF	02 00	C0 30	00 00	
OSD MESSAGE	Set	OFF	BE EF	03	06 00	8F D6	01 00	17 30	00 00
		ON	BE EF	03	06 00	1F D7	01 00	17 30	01 00
		HIDE	BE EF	03	06 00	EF D7	01 00	17 30	02 00
	Get	BE EF	03	06 00	BC D6	02 00	17 30	00 00	
TEMPLATE	Set	TEST PATTERN	BE EF	03	06 00	43 D9	01 00	22 30	00 00
		DOT-LINE 1	BE EF	03	06 00	D3 D8	01 00	22 30	01 00
		DOT-LINE 2	BE EF	03	06 00	23 D8	01 00	22 30	02 00
		DOT-LINE 3	BE EF	03	06 00	B3 D9	01 00	22 30	03 00
		DOT-LINE 4	BE EF	03	06 00	83 DB	01 00	22 30	04 00
		CIRCLE 1	BE EF	03	06 00	13 DA	01 00	22 30	05 00
		CIRCLE 2	BE EF	03	06 00	E3 DA	01 00	22 30	06 00
		MAP 1	BE EF	03	06 00	83 D4	01 00	22 30	10 00
		MAP 2	BE EF	03	06 00	13 D5	01 00	22 30	11 00
	STACK	BE EF	03	06 00	83 C0	01 00	22 30	20 00	
Get	BE EF	03	06 00	70 D9	02 00	22 30	00 00		
TEMPLATE On/Off	Set	OFF	BE EF	03	06 00	BF D8	01 00	23 30	00 00
		ON	BE EF	03	06 00	2F D9	01 00	23 30	01 00
	Get	BE EF	03	06 00	8C D8	02 00	23 30	00 00	
Closed Caption C. C. - DISPLAY	Set	OFF	BE EF	03	06 00	FA 62	01 00	00 37	00 00
		ON	BE EF	03	06 00	6A 63	01 00	00 37	01 00
		AUTO	BE EF	03	06 00	9A 63	01 00	00 37	02 00
	Get	BE EF	03	06 00	C9 62	02 00	00 37	00 00	
Closed Caption C. C. - MODE	Set	CAPTIONS	BE EF	03	06 00	06 63	01 00	01 37	00 00
		TEXT	BE EF	03	06 00	96 62	01 00	01 37	01 00
	Get	BE EF	03	06 00	35 63	02 00	01 37	00 00	
Closed Caption C. C. - CHANNEL	Set	1	BE EF	03	06 00	D2 62	01 00	02 37	01 00
		2	BE EF	03	06 00	22 62	01 00	02 37	02 00
		3	BE EF	03	06 00	B2 63	01 00	02 37	03 00
		4	BE EF	03	06 00	82 61	01 00	02 37	04 00
	Get	BE EF	03	06 00	71 63	02 00	02 37	00 00	
SOURCE SKIP - COMPUTER IN	Set	NORMAL	BE EF	03	06 00	FE 78	01 00	20 22	00 00
		SKIP	BE EF	03	06 00	6E 79	01 00	20 22	01 00
	Get	BE EF	03	06 00	CD 78	02 00	20 22	00 00	
SOURCE SKIP - LAN	Set	NORMAL	BE EF	03	06 00	DA 7A	01 00	2B 22	00 00
		SKIP	BE EF	03	06 00	4A 7B	01 00	2B 22	01 00
	Get	BE EF	03	06 00	E9 7A	02 00	2B 22	00 00	
SOURCE SKIP - HDMI 1	Set	NORMAL	BE EF	03	06 00	BA 78	01 00	23 22	00 00
		SKIP	BE EF	03	06 00	2A 79	01 00	23 22	01 00
	Get	BE EF	03	06 00	89 78	02 00	23 22	00 00	
SOURCE SKIP - HDMI 2	Set	NORMAL	BE EF	03	06 00	52 7A	01 00	2D 22	00 00
		SKIP	BE EF	03	06 00	C2 7B	01 00	2D 22	01 00
	Get	BE EF	03	06 00	61 7A	02 00	2D 22	00 00	
SOURCE SKIP - HDBaseT	Set	NORMAL	BE EF	03	06 00	B6 EA	01 00	D6 20	00 00
		SKIP	BE EF	03	06 00	26 EB	01 00	D6 20	01 00
	Get	BE EF	03	06 00	85 EA	02 00	D6 20	00 00	

Names	Operation Type	Header				CRC	Command Data		
							Action	Type	Setting code
SOURCE SKIP - VIDEO	Set	NORMAL	BE EF	03	06 00	02 79	01 00	21 22	00 00
		SKIP	BE EF	03	06 00	92 78	01 00	21 22	01 00
	Get	BE EF	03	06 00	31 79	02 00	21 22	00 00	
SOURCE SKIP SDI*	Set	NORMAL	BE EF	03	06 00	B6 E5	01 00	E6 20	00 00
		SKIP	BE EF	03	06 00	26 E4	01 00	E6 20	01 00
	Get	BE EF	03	06 00	85 E5	02 00	E6 20	00 00	
SOURCE SKIP DisplayPort	Set	NORMAL	BE EF	03	06 00	76 E1	01 00	F6 20	00 00
		SKIP	BE EF	03	06 00	E6 E0	01 00	F6 20	01 00
	Get	BE EF	03	06 00	45 E1	02 00	F6 20	00 00	
AUTO SEARCH	Set	OFF	BE EF	03	06 00	B6 D6	01 00	16 20	00 00
		ON	BE EF	03	06 00	26 D7	01 00	16 20	01 00
	Get	BE EF	03	06 00	85 D6	02 00	16 20	00 00	
DIRECT POWER ON	Set	OFF	BE EF	03	06 00	3B 89	01 00	20 31	00 00
		ON	BE EF	03	06 00	AB 88	01 00	20 31	01 00
	Get	BE EF	03	06 00	08 89	02 00	20 31	00 00	
AUTO POWER OFF	Get	BE EF	03	06 00	08 86	02 00	10 31	00 00	
	Increment	BE EF	03	06 00	6E 86	04 00	10 31	00 00	
	Decrement	BE EF	03	06 00	BF 87	05 00	10 31	00 00	
SHUTTER TIMER	Set	1h	BE EF	03	06 00	27 92	01 00	06 24	01 00
		3h	BE EF	03	06 00	47 93	01 00	06 24	03 00
		6h	BE EF	03	06 00	17 90	01 00	06 24	06 00
	Get	BE EF	03	06 00	84 93	02 00	06 24	00 00	
LAMP TIME Lower Bytes	Get	BE EF	03	06 00	C2 FF	02 00	90 10	00 00	
LAMP TIME Higher Bytes	Get	BE EF	03	06 00	2A FD	02 00	9E 10	00 00	
LAMP TIME Reset	Execute	BE EF	03	06 00	58 DC	06 00	30 70	00 00	
FILTER TIME Lower Bytes	Get	BE EF	03	06 00	C2 F0	02 00	A0 10	00 00	
FILTER TIME Higher Bytes	Get	BE EF	03	06 00	D6 FC	02 00	9F 10	00 00	
FILTER TIME Reset	Execute	BE EF	03	06 00	98 C6	06 00	40 70	00 00	

* Supported only for LWU701i

Names	Operation Type	Header			CRC	Command Data		
						Action	Type	Setting code
MY BUTTON-1	MY IMAGE	BE EF	03	06 00	5A 3D	01 00	00 36	16 00
	MESSENGER	BE EF	03	06 00	AA 29	01 00	00 36	25 00
	SHUTTER	BE EF	03	06 00	5A 26	01 00	00 36	32 00
	INFORMATION	BE EF	03	06 00	FA 3E	01 00	00 36	10 00
	MY MEMORY	BE EF	03	06 00	9A 3F	01 00	00 36	12 00
	DYNAMIC IRIS	BE EF	03	06 00	AA 3D	01 00	00 36	15 00
	PICTURE MODE	BE EF	03	06 00	0A 3E	01 00	00 36	13 00
	FILTER RESET	BE EF	03	06 00	3A 3C	01 00	00 36	14 00
	TEMPLATE	BE EF	03	06 00	CA 39	01 00	00 36	1B 00
	MUTE	BE EF	03	06 00	FA 20	01 00	00 36	38 00
	PbyP/PIP SWAP	BE EF	03	06 00	5A 38	01 00	00 36	1A 00
	PIP POSITION	BE EF	03	06 00	3A 22	01 00	00 36	3C 00
	BLANK	BE EF	03	06 00	FA 02	01 00	00 36	40 00
	RESOLUTION	BE EF	03	06 00	9A 3A	01 00	00 36	1E 00
	ECO MODE	BE EF	03	06 00	0A 25	01 00	00 36	37 00
	eClarity	BE EF	03	06 00	9A 21	01 00	00 36	3A 00
	HDCR	BE EF	03	06 00	5A 23	01 00	00 36	3E 00
STATUS MONITOR	BE EF	03	06 00	0A 20	01 00	00 36	3B 00	
Get	BE EF	03	06 00	09 33	02 00	00 36	00 00	
MY BUTTON-2	MY IMAGE	BE EF	03	06 00	A6 3C	01 00	01 36	16 00
	MESSENGER	BE EF	03	06 00	56 28	01 00	01 36	25 00
	SHUTTER	BE EF	03	06 00	A6 27	01 00	01 36	32 00
	INFORMATION	BE EF	03	06 00	06 3F	01 00	01 36	10 00
	MY MEMORY	BE EF	03	06 00	66 3E	01 00	01 36	12 00
	DYNAMIC IRIS	BE EF	03	06 00	56 3C	01 00	01 36	15 00
	PICTURE MODE	BE EF	03	06 00	F6 3F	01 00	01 36	13 00
	FILTER RESET	BE EF	03	06 00	C6 3D	01 00	01 36	14 00
	TEMPLATE	BE EF	03	06 00	36 38	01 00	01 36	1B 00
	MUTE	BE EF	03	06 00	06 21	01 00	01 36	38 00
	PbyP/PIP SWAP	BE EF	03	06 00	A6 39	01 00	01 36	1A 00
	PIP POSITION	BE EF	03	06 00	C6 23	01 00	01 36	3C 00
	BLANK	BE EF	03	06 00	06 03	01 00	01 36	40 00
	RESOLUTION	BE EF	03	06 00	66 3B	01 00	01 36	1E 00
	ECO MODE	BE EF	03	06 00	F6 24	01 00	01 36	37 00
	eClarity	BE EF	03	06 00	66 20	01 00	01 36	3A 00
	HDCR	BE EF	03	06 00	A6 22	01 00	01 36	3E 00
STATUS MONITOR	BE EF	03	06 00	F6 21	01 00	01 36	3B 00	
Get	BE EF	03	06 00	F5 32	02 00	01 36	00 00	

RS-232C Communication / Network command table (continued)

Names	Operation Type	Header			CRC	Command Data		
						Action	Type	Setting code
MY BUTTON-3	MY IMAGE	BE EF	03	06 00	E2 3C	01 00	02 36	16 00
	MESSENGER	BE EF	03	06 00	12 28	01 00	02 36	25 00
	SHUTTER	BE EF	03	06 00	E2 27	01 00	02 36	32 00
	INFORMATION	BE EF	03	06 00	42 3F	01 00	02 36	10 00
	MY MEMORY	BE EF	03	06 00	22 3E	01 00	02 36	12 00
	DYNAMIC IRIS	BE EF	03	06 00	12 3C	01 00	02 36	15 00
	PICTURE MODE	BE EF	03	06 00	B2 3F	01 00	02 36	13 00
	FILTER RESET	BE EF	03	06 00	82 3D	01 00	02 36	14 00
	TEMPLATE	BE EF	03	06 00	72 38	01 00	02 36	1B 00
	MUTE	BE EF	03	06 00	42 21	01 00	02 36	38 00
	PbyP/PIP SWAP	BE EF	03	06 00	E2 39	01 00	02 36	1A 00
	PIP POSITION	BE EF	03	06 00	82 23	01 00	02 36	3C 00
	BLANK	BE EF	03	06 00	42 03	01 00	02 36	40 00
	RESOLUTION	BE EF	03	06 00	22 3B	01 00	02 36	1E 00
	ECO MODE	BE EF	03	06 00	B2 24	01 00	02 36	37 00
	eClarity	BE EF	03	06 00	22 20	01 00	02 36	3A 00
	HDCR	BE EF	03	06 00	E2 22	01 00	02 36	3E 00
STATUS MONITOR	BE EF	03	06 00	B2 21	01 00	02 36	3B 00	
Get	BE EF	03	06 00	B1 32	02 00	02 36	00 00	
MY BUTTON-4	MY IMAGE	BE EF	03	06 00	1E 3D	01 00	03 36	16 00
	MESSENGER	BE EF	03	06 00	EE 29	01 00	03 36	25 00
	SHUTTER	BE EF	03	06 00	1E 26	01 00	03 36	32 00
	INFORMATION	BE EF	03	06 00	BE 3E	01 00	03 36	10 00
	MY MEMORY	BE EF	03	06 00	DE 3F	01 00	03 36	12 00
	DYNAMIC IRIS	BE EF	03	06 00	EE 3D	01 00	03 36	15 00
	PICTURE MODE	BE EF	03	06 00	4E 3E	01 00	03 36	13 00
	FILTER RESET	BE EF	03	06 00	7E 3C	01 00	03 36	14 00
	TEMPLATE	BE EF	03	06 00	8E 39	01 00	03 36	1B 00
	MUTE	BE EF	03	06 00	BE 20	01 00	03 36	38 00
	PbyP/PIP SWAP	BE EF	03	06 00	1E 38	01 00	03 36	1A 00
	PIP POSITION	BE EF	03	06 00	7E 22	01 00	03 36	3C 00
	BLANK	BE EF	03	06 00	BE 02	01 00	03 36	40 00
	RESOLUTION	BE EF	03	06 00	DE 3A	01 00	03 36	1E 00
	ECO MODE	BE EF	03	06 00	4E 25	01 00	03 36	37 00
	eClarity	BE EF	03	06 00	DE 21	01 00	03 36	3A 00
	HDCR	BE EF	03	06 00	1E 23	01 00	03 36	3E 00
STATUS MONITOR	BE EF	03	06 00	4E 20	01 00	03 36	3B 00	
Get	BE EF	03	06 00	4D 33	02 00	03 36	00 00	

Names	Operation Type	Header			CRC	Command Data			
						Action	Type	Setting code	
REMOTE RECEIV. FRONT	Set	Off	BE EF	03	06 00	FF 32	01 00	00 26	00 00
		On	BE EF	03	06 00	6F 33	01 00	00 26	01 00
	Get	BE EF	03	06 00	CC 32	02 00	00 26	00 00	
REMOTE RECEIV. REAR	Set	Off	BE EF	03	06 00	03 33	01 00	01 26	00 00
		On	BE EF	03	06 00	93 32	01 00	01 26	01 00
	Get	BE EF	03	06 00	30 33	02 00	01 26	00 00	
REMOTE RECEIV.HDBaseT	Set	Off	BE EF	03	06 00	BB 32	01 00	03 26	00 00
		On	BE EF	03	06 00	2B 33	01 00	03 26	01 00
	Get	BE EF	03	06 00	88 32	02 00	03 26	00 00	
REMOTE FREQ. NORMAL	Set	OFF	BE EF	03	06 00	FF 3D	01 00	30 26	00 00
		ON	BE EF	03	06 00	6F 3C	01 00	30 26	01 00
	Get	BE EF	03	06 00	CC 3D	02 00	30 26	00 00	
REMOTE FREQ. HIGH	Set	OFF	BE EF	03	06 00	03 3C	01 00	31 26	00 00
		ON	BE EF	03	06 00	93 3D	01 00	31 26	01 00
	Get	BE EF	03	06 00	30 3C	02 00	31 26	00 00	
REMOTE ID	Set	ALL	BE EF	03	06 00	9F 30	01 00	08 26	00 00
		1	BE EF	03	06 00	0F 31	01 00	08 26	01 00
		2	BE EF	03	06 00	FF 31	01 00	08 26	02 00
		3	BE EF	03	06 00	6F 30	01 00	08 26	03 00
		4	BE EF	03	06 00	5F 32	01 00	08 26	04 00
	Get	BE EF	03	06 00	AC 30	02 00	08 26	00 00	
MY IMAGE	Set	OFF	BE EF	03	06 00	3A C3	01 00	00 35	00 00
		IMAGE-1	BE EF	03	06 00	AA C2	01 00	00 35	01 00
		IMAGE-2	BE EF	03	06 00	5A C2	01 00	00 35	02 00
		IMAGE-3	BE EF	03	06 00	CA C3	01 00	00 35	03 00
		IMAGE-4	BE EF	03	06 00	FA C1	01 00	00 35	04 00
	Get	BE EF	03	06 00	09 C3	02 00	00 35	00 00	
MY IMAGE IMAGE-1 Delete	Execute	BE EF	03	06 00	71 C3	06 00	01 35	00 00	
MY IMAGE IMAGE-2 Delete	Execute	BE EF	03	06 00	35 C3	06 00	02 35	00 00	
MY IMAGE IMAGE-3 Delete	Execute	BE EF	03	06 00	C9 C2	06 00	03 35	00 00	
MY IMAGE IMAGE-4 Delete	Execute	BE EF	03	06 00	BD C3	06 00	04 35	00 00	
Advanced Color Adjustment HUE R	Get	BE EF	03	06 00	0C 63	02 00	00 27	00 00	
	Increment	BE EF	03	06 00	6A 63	04 00	00 27	00 00	
	Decrement	BE EF	03	06 00	BB 62	05 00	00 27	00 00	
Advanced Color Adjustment HUE R Reset	Execute	BE EF	03	06 00	98 EB	06 00	D0 70	00 00	
Advanced Color Adjustment HUE Y	Get	BE EF	03	06 00	F0 62	02 00	01 27	00 00	
	Increment	BE EF	03	06 00	96 62	04 00	01 27	00 00	
	Decrement	BE EF	03	06 00	47 63	05 00	01 27	00 00	
Advanced Color Adjustment HUE Y Reset	Execute	BE EF	03	06 00	64 EA	06 00	D1 70	00 00	

RS-232C Communication / Network command table (continued)

Names	Operation Type	Header			CRC	Command Data		
						Action	Type	Setting code
Advanced Color Adjustment HUE G	Get	BE EF	03	06 00	B4 62	02 00	02 27	00 00
	Increment	BE EF	03	06 00	D2 62	04 00	02 27	00 00
	Decrement	BE EF	03	06 00	03 63	05 00	02 27	00 00
Advanced Color Adjustment HUE G Reset	Execute	BE EF	03	06 00	20 EA	06 00	D2 70	00 00
Advanced Color Adjustment HUE C	Get	BE EF	03	06 00	48 63	02 00	03 27	00 00
	Increment	BE EF	03	06 00	2E 63	04 00	03 27	00 00
	Decrement	BE EF	03	06 00	FF 62	05 00	03 27	00 00
Advanced Color Adjustment HUE C Reset	Execute	BE EF	03	06 00	DC EB	06 00	D3 70	00 00
Advanced Color Adjustment HUE B	Get	BE EF	03	06 00	3C 62	02 00	04 27	00 00
	Increment	BE EF	03	06 00	5A 62	04 00	04 27	00 00
	Decrement	BE EF	03	06 00	8B 63	05 00	04 27	00 00
Advanced Color Adjustment HUE B Reset	Execute	BE EF	03	06 00	A8 EA	06 00	D4 70	00 00
Advanced Color Adjustment HUE M	Get	BE EF	03	06 00	C0 63	02 00	05 27	00 00
	Increment	BE EF	03	06 00	A6 63	04 00	05 27	00 00
	Decrement	BE EF	03	06 00	77 62	05 00	05 27	00 00
Advanced Color Adjustment HUE M Reset	Execute	BE EF	03	06 00	54 EB	06 00	D5 70	00 00
Advanced Color Adjustment SATURATION R	Get	BE EF	03	06 00	CC 67	02 00	10 27	00 00
	Increment	BE EF	03	06 00	AA 67	04 00	10 27	00 00
	Decrement	BE EF	03	06 00	7B 66	05 00	10 27	00 00
Advanced Color Adjustment SATURATION R Reset	Execute	BE EF	03	06 00	F8 E9	06 00	D8 70	00 00
Advanced Color Adjustment SATURATION Y	Get	BE EF	03	06 00	30 66	02 00	11 27	00 00
	Increment	BE EF	03	06 00	56 66	04 00	11 27	00 00
	Decrement	BE EF	03	06 00	87 67	05 00	11 27	00 00
Advanced Color Adjustment SATURATION Y Reset	Execute	BE EF	03	06 00	04 E8	06 00	D9 70	00 00
Advanced Color Adjustment SATURATION G	Get	BE EF	03	06 00	74 66	02 00	12 27	00 00
	Increment	BE EF	03	06 00	12 66	04 00	12 27	00 00
	Decrement	BE EF	03	06 00	C3 67	05 00	12 27	00 00
Advanced Color Adjustment SATURATION G Reset	Execute	BE EF	03	06 00	40 E8	06 00	DA 70	00 00
Advanced Color Adjustment SATURATION C	Get	BE EF	03	06 00	88 67	02 00	13 27	00 00
	Increment	BE EF	03	06 00	EE 67	04 00	13 27	00 00
	Decrement	BE EF	03	06 00	3F 66	05 00	13 27	00 00
Advanced Color Adjustment SATURATION C Reset	Execute	BE EF	03	06 00	BC E9	06 00	DB 70	00 00

Names	Operation Type	Header			CRC	Command Data		
						Action	Type	Setting code
Advanced Color Adjustment SATURATION B	Get	BE EF	03	06 00	FC 66	02 00	14 27	00 00
	Increment	BE EF	03	06 00	9A 66	04 00	14 27	00 00
	Decrement	BE EF	03	06 00	4B 67	05 00	14 27	00 00
Advanced Color Adjustment SATURATION B Reset	Execute	BE EF	03	06 00	C8 E8	06 00	DC 70	00 00
Advanced Color Adjustment SATURATION M	Get	BE EF	03	06 00	00 67	02 00	15 27	00 00
	Increment	BE EF	03	06 00	66 67	04 00	15 27	00 00
	Decrement	BE EF	03	06 00	B7 66	05 00	15 27	00 00
Advanced Color Adjustment SATURATION M Reset	Execute	BE EF	03	06 00	34 E9	06 00	DD 70	00 00
Advanced Color Adjustment LUMINANCE R	Get	BE EF	03	06 00	CC 68	02 00	20 27	00 00
	Increment	BE EF	03	06 00	AA 68	04 00	20 27	00 00
	Decrement	BE EF	03	06 00	7B 69	05 00	20 27	00 00
Advanced Color Adjustment LUMINANCE R Reset	Execute	BE EF	03	06 00	98 E4	06 00	E0 70	00 00
Advanced Color Adjustment LUMINANCE Y	Get	BE EF	03	06 00	30 69	02 00	21 27	00 00
	Increment	BE EF	03	06 00	56 69	04 00	21 27	00 00
	Decrement	BE EF	03	06 00	87 68	05 00	21 27	00 00
Advanced Color Adjustment LUMINANCE Y Reset	Execute	BE EF	03	06 00	64 E5	06 00	E1 70	00 00
Advanced Color Adjustment LUMINANCE G	Get	BE EF	03	06 00	74 69	02 00	22 27	00 00
	Increment	BE EF	03	06 00	12 69	04 00	22 27	00 00
	Decrement	BE EF	03	06 00	C3 68	05 00	22 27	00 00
Advanced Color Adjustment LUMINANCE G Reset	Execute	BE EF	03	06 00	20 E5	06 00	E2 70	00 00
Advanced Color Adjustment LUMINANCE C	Get	BE EF	03	06 00	88 68	02 00	23 27	00 00
	Increment	BE EF	03	06 00	EE 68	04 00	23 27	00 00
	Decrement	BE EF	03	06 00	3F 69	05 00	23 27	00 00
Advanced Color Adjustment LUMINANCE C Reset	Execute	BE EF	03	06 00	DC E4	06 00	E3 70	00 00
Advanced Color Adjustment LUMINANCE B	Get	BE EF	03	06 00	FC 69	02 00	24 27	00 00
	Increment	BE EF	03	06 00	9A 69	04 00	24 27	00 00
	Decrement	BE EF	03	06 00	4B 68	05 00	24 27	00 00
Advanced Color Adjustment LUMINANCE B Reset	Execute	BE EF	03	06 00	A8 E5	06 00	E4 70	00 00
Advanced Color Adjustment LUMINANCE M	Get	BE EF	03	06 00	00 68	02 00	25 27	00 00
	Increment	BE EF	03	06 00	66 68	04 00	25 27	00 00
	Decrement	BE EF	03	06 00	B7 69	05 00	25 27	00 00
Advanced Color Adjustment LUMINANCE M Reset	Execute	BE EF	03	06 00	54 E4	06 00	E5 70	00 00

PJLink command

Commands	Control Description	Parameter or Response
POWR	Power Control	0 = Standby 1 = Power On
POWR ?	Power Status inquiry	0 = Standby 1 = Power On 2 = Cool Down
INPT (LWU601i/ LW651i/ LW751i/ LX801i)	Input Source selection	11 = COMPUTER IN 23 = VIDEO 31 = HDMI 1 33 = HDMI 2 36 = HDBaseT 51 = LAN
INPT ? (LWU601i/ LW651i/ LW751i/ LX801i)	Input Source inquiry	11 = COMPUTER IN 23 = VIDEO 31 = HDMI 1 33 = HDMI 2 36 = HDBaseT 51 = LAN
INPT (LWU701i)	Input Source selection	11 = COMPUTER IN 23 = VIDEO 31 = HDMI 1 33 = HDMI 2 36 = HDBaseT 37 = SDI 51 = LAN
INPT ? (LWU701i)	Input Source inquiry	11 = COMPUTER IN 23 = VIDEO 31 = HDMI 1 33 = HDMI 2 36 = HDBaseT 37 = SDI 51 = LAN
AVMT	AV Mute	10 = BLANK off 11 = BLANK on 20 = Mute off 21 = Mute on 30 = AV Mute off 31 = AV Mute on

(continued on next page)

Commands	Control Description	Parameter or Response
AVMT ?	AV Mute inquiry	10 = BLANK off 11 = BLANK on 20 = Mute off 21 = Mute on 30 = AV Mute off 31 = AV Mute on
ERST ?	Error Status inquiry	1st byte: Refers to Fan error; one of 0 to 2 2nd byte: Refers to Lamp error; one of 0 to 2 3rd byte: Refers to Temperature error; one of 0 to 2 4th byte: Refers to Cover error; one of 0 to 2 5th byte: Refers to Filter error; one of 0 to 2 6th byte: Refers to Other error; one of 0 to 2 The meaning of 0 to 2 is as given below 0 = Error is not detected 1 = Warning 2 = Error
LAMP ?	Lamp Status inquiry	1st number (digits 1 to 5): Lamp Time 2nd number : 0 = Lamp off, 1 = Lamp on
INST ?	Input Source List inquiry	11 23 31 33 36 37(LWU701i only) 51
NAME ?	Projector Name inquiry	Responds with the name set in the item PROJECTOR NAME of the NETWORK menu
INF1 ?	Manufacturer's Name inquiry	CHRISTIE
INF2 ?	Model Name inquiry	LWU601i LW651i LWU701i LW751i LX801i
INFO ?	Other Information inquiry	Responds with the factory information and so on
CLSS ?	Class Information inquiry	1

NOTE • The password used in PJLink™ is the same as the password set in the Web Control. To use PJLink™ without authentication, do not set any password in Web Browser Control.

• For specifications of PJLink™, see the web site of the Japan Business Machine and Information System Industries Association.

URL: <http://pjlink.jbmia.or.jp/>

Corporate offices

USA – Cypress
ph: 714-236-8610

Canada – Kitchener
ph: 519-744-8005

Consultant offices

Italy
ph: +39 (0) 2 9902 1161

Worldwide offices

Australia
ph: +61 (0) 7 3624 4888

Brazil
ph: +55 (11) 2548 4753

China (Beijing)
ph: +86 10 6561 0240

China (Shanghai)
ph: +86 21 6278 7708

Eastern Europe and
Russian Federation
ph: +36 (0) 1 47 48 100

France
ph: +33 (0) 1 41 21 44 04

Germany
ph: +49 2161 664540

India
ph: +91 (080) 6708 9999

Japan
ph: 81-3-3599-7481

Korea (Seoul)
ph: +82 2 702 1601

Republic of South Africa
ph: +27 (0)11 510 0094

Singapore
ph: +65 6877-8737

Spain
ph: + 34 91 633 9990

United Arab Emirates
ph: +971 4 3206688

United Kingdom
ph: +44 118 977 8000



For the most current technical documentation,
please visit www.christiedigital.com

CHRISTIE®