

# Panasonic<sup>®</sup>

## Operating Instructions

---

Remote Camera Controller

Model No. **AW-RP60G**

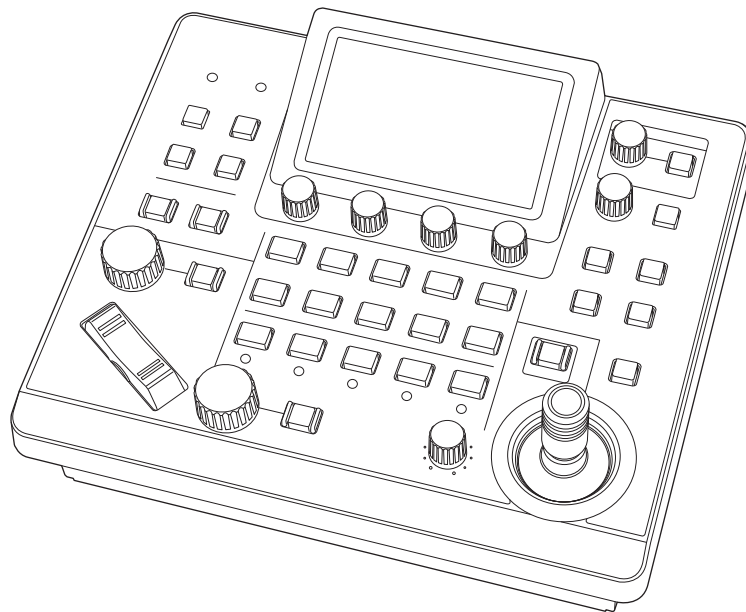

Before operating this product, please read the instructions carefully and save this manual for future use. Please carefully read the "Read this first!" (pages 3 to 4) of this Manual before use.

<b>Български</b>	Посетете следния уебсайт относно информация за безопасността и важни уведомления за продукта.	<b>Latviešu</b>	Lai iegūtu informāciju par drošību un skatītu svarīgus paziņojumus par šo produktu, apmeklējiet tālāk norādīto tīmekļa vietni.
<b>Hrvatski</b>	Za sigurnosne informacije i važne obavijesti o proizvodu posjetite sljedeću internetsku stranicu.	<b>Lietuvių</b>	Jei reikia saugos informacijos ir svarbių pranešimų apie gaminį, apsilankykite toliau nurodytoje svetainėje.
<b>Čeština</b>	Na následujícím webu najdete bezpečnostní informace a důležité poznámky k tomuto produktu.	<b>Polski</b>	Informacje o bezpieczeństwie i ważne informacje o produkcie znajdują się w poniższej witrynie internetowej.
<b>Dansk</b>	Besøg følgende webside for sikkerhedsinformation og vigtige bemærkninger vedrørende produktet.	<b>Português</b>	Consulte o seguinte website para as informações de segurança e importantes notificações sobre o produto.
<b>Nederlands</b>	Ga naar de volgende website voor veiligheidsinformatie en belangrijke meldingen over het product.	<b>Română</b>	Vizitați următoarea pagină web pentru informații de securitate și notificări importante cu privire la produs.
<b>Eesti</b>	Toodet puudutava ohutusteabe ja oluliste märkuste saamiseks külastage järgmist veebilehte.	<b>Slovensky</b>	Pre bezpečnostné informácie a dôležité oznámenia súvisiace s produktom navštívte túto webovú stránku.
<b>Suomi</b>	Käy seuraavalla verkkosivulla saadaksesi turvallisuustietoja ja tärkeitä tietoja liittyen laitteeseen.	<b>Slovenščina</b>	Za varnostne informacije in pomembna obvestila v zvezi z izdelkom obiščite naslednje spletno mesto.
<b>Ελληνικά</b>	Για πληροφορίες σχετικά με θέματα ασφάλειας και σημαντικές ειδοποιήσεις που αφορούν το προϊόν σας, επισκεφτείτε τον ιστότοπο που ακολουθεί.	<b>Svenska</b>	Besök följande webbplats för säkerhetsinformation och viktiga meddelanden om produkten.
<b>Magyar</b>	A termékkel kapcsolatos biztonsági információkért és fontos értesítésekért látogasson el az alábbi weboldalra.	<b>العربية</b>	زر موقع الويب التالي لمعرفة أحدث معلومات السلامة والإخطارات الهامة بشأن المنتج.

<https://pro-av.panasonic.net/manual/en/index.html>

#### About trademarks and registered trademarks

- Microsoft®, Windows®, Windows® 7, Windows® 10 and Internet Explorer® are registered trademarks or trademarks of Microsoft Corporation in the United States, Japan, and/or other countries.
- Other company names and product names appearing in this manual are the registered trademarks or trademarks of their respective companies.

#### Copyrights

It is prohibited to transfer, copy, disassemble, decompile, and reverse engineer the software included with the unit, as well as export it in violation of the export laws.

#### Illustrations and screen images in this manual

- Illustrations of the unit and screens may appear different from the actual unit and screens.
- The screenshots are used in accordance with the guidelines of Microsoft Corporation.

#### Abbreviations

The following abbreviations are used in this manual.

- Microsoft® Windows® 7 Professional SP1 32/64-bit is referred to as "Windows 7".
- In these instructions, the phrases "Integrated Camera" and "pan-tilt head and camera combination" are referred to collectively as "remote camera" except in places where specific equipment is mentioned.

Furthermore, the product numbers of equipment are referred to as follows.

Model number of unit	Model number given in manual
AW-RP60G	<b>AW-RP60</b>
AW-HE35SKED, AW-HE35SWED	<b>AW-HE35</b>
AW-HE38HKED, AW-HE38HWED, AW-HE38SKED, AW-HE38SWED, AW-HE38HKE, AW-HE38HWP, AW-HE38HKE, AW-HE38HWE, AW-HE38HKPC, AW-HE38HWPC	<b>AW-HE38</b>
AW-HE40HKE, AW-HE40HWP, AW-HE40HKE, AW-HE40HWE, AW-HE40SKP, AW-HE40SWP, AW-HE40SKE, AW-HE40SWE	<b>AW-HE40</b>
AW-HE42KP, AW-HE42WP, AW-HE42KE, AW-HE42WE	<b>AW-HE42</b>
AW-HN38HKE, AW-HN38HWP, AW-HN38HKE, AW-HN38HWE, AW-HN38HKPC, AW-HN38HWPC	<b>AW-HN38</b>
AW-HN40HKE, AW-HN40HWP, AW-HN40HKE, AW-HN40HWE, AW-HN40HKPC, AW-HN40HWPC	<b>AW-HN40</b>
AW-UE70KP, AW-UE70WP, AW-UE70KE, AW-UE70WE	<b>AW-UE70</b>
AW-UN70KP, AW-UN70WP, AW-UN70KE, AW-UN70WE, AW-UN70KPC, AW-UN70WPC	<b>AW-UN70</b>

# Read this first!

## WARNING:

Installation should only be performed by qualified installation personnel. Improper installation may result in the entire apparatus falling down and causing injury.

## WARNING:

- To reduce the risk of fire, do not expose this equipment to rain or moisture.
- To reduce the risk of fire, keep this equipment away from all liquids.  
Use and store only in locations which are not exposed to the risk of dripping or splashing liquids, and do not place any liquid containers on top of the equipment.

## WARNING:

This equipment is compliant with Class A of CISPR 32. In a residential environment this equipment may cause radio interference.

## CAUTION:

Do not remove panel covers by unscrewing. To reduce the risk of electric shock, do not remove the covers. No user serviceable parts inside. Refer servicing to qualified service personnel.

## CAUTION:

To reduce the risk of fire or electric shock and annoying interference, use the recommended accessories only.

## CAUTION:

In order to maintain adequate ventilation, do not install or place this unit in a bookcase, built-in cabinet or any other confined space. To prevent risk of electric shock or fire hazard due to overheating, ensure that curtains and any other materials do not obstruct the ventilation.

 indicates safety information.

## FCC NOTICE (USA)

### Supplier's Declaration of Conformity

Model Number: AW-RP60G  
Trade Name: Panasonic  
Responsible Party: Panasonic Corporation of North America  
Two Riverfront Plaza, Newark, NJ 07102  
Support contact: 1-800-524-1448

This device complies with part 15 of the FCC Rules.

Operation is subject to the following two conditions:

(1) This device may not cause harmful interference, and (2) this device must accept any interference received, including interference that may cause undesired operation.

### FCC Note:

This equipment has been tested and found to comply with the limits for a class A digital device, pursuant to Part 15 of the FCC Rules. These limits are designed to provide reasonable protection against harmful interference when the equipment is operated in a commercial environment. This equipment generates, uses, and can radiate radio frequency energy, and if not installed and used in accordance with the instruction manual, may cause harmful interference to radio communications. Operation of this equipment in a residential area is likely to cause harmful interference in which case the user will be required to correct the interference at his own expense.

### Warning:

To assure continued FCC emission limit compliance, the user must use only shielded interface cables when connecting to external units. Also, any unauthorized changes or modifications to this equipment could void the user's authority to operate it.

## NOTIFICATION (Canada)

CAN ICES-003 (A)/NMB-003(A)

 indicates safety information.

**Turkey Only**  
**AEEE Yönetmeliğine Uygundur.**  
**AEEE Complies with Directive of Turkey.**

## EMC NOTICE FOR THE PURCHASER/USER OF THE APPARATUS

### 1. Pre-requisite conditions to achieving compliance with the above standards

#### <1> Peripheral equipment to be connected to the apparatus and special connecting cables

- The purchaser/user is urged to use only equipment which has been recommended by us as peripheral equipment to be connected to the apparatus.
- The purchaser/user is urged to use only the connecting cables described below.

#### <2> For the connecting cables, use shielded cables which suit the intended purpose of the apparatus.

- Video signal connecting cables  
Use double shielded coaxial cables, which are designed for 75-ohm type high-frequency applications, for SDI (Serial Digital Interface).  
Coaxial cables, which are designed for 75-ohm type high-frequency applications, are recommended for analog video signals.
- Audio signal connecting cables  
If your apparatus supports AES/EBU serial digital audio signals, use cables designed for AES/EBU.  
Use shielded cables, which provide quality performance for high-frequency transmission applications, for analog audio signals.
- Other connecting cables (LAN, RS-422)  
Use shielded cables, which provide quality performance for high-frequency applications, as connecting cables.
- When connecting to the DVI signal terminal, use a cable with a ferrite core.
- If your apparatus is supplied with ferrite core(s), they must be attached on cable(s) following instructions in this manual.

### 2. Performance level

The performance level of the apparatus is equivalent to or better than the performance level required by these standards. However, the apparatus may be adversely affected by interference if it is being used in an EMC environment, such as an area where strong electromagnetic fields are generated (by the presence of signal transmission towers, cellular phones, etc.). In order to minimize the adverse effects of the interference on the apparatus in cases like this, it is recommended that the following steps be taken with the apparatus being affected and with its operating environment:

1. Place the apparatus at a distance from the source of the interference.
2. Change the direction of the apparatus.
3. Change the connection method used for the apparatus.
4. Connect the apparatus to another power outlet where the power is not shared by any other appliances.



#### Disposal of Old Equipment

##### Only for European Union and countries with recycling systems

This symbol on the products, packaging, and/or accompanying documents means that used electrical and electronic products must not be mixed with general household waste.

For proper treatment, recovery and recycling of old products, please take them to applicable collection points in accordance with your national legislation.

By disposing of them correctly, you will help to save valuable resources and prevent any potential negative effects on human health and the environment.

For more information about collection and recycling, please contact your local municipality, dealer or supplier.

Penalties may be applicable for incorrect disposal of this waste, in accordance with national legislation.

#### Manufactured by:

Panasonic Connect Co., Ltd.  
4-1-62 Minoshima, Hakata-ku, Fukuoka 812-8531, Japan

#### Importer:

Panasonic Connect Europe GmbH

#### Authorized Representative in EU:

Panasonic Testing Centre  
Winsbergring 15, 22525 Hamburg, Germany

#### Importer for UK:

Panasonic Connect UK,  
a branch of Panasonic Connect Europe GmbH,  
Maxis 2, Western Road, Bracknell, Berkshire, RG12 1RT



# Contents

---

<b>Read this first!</b> .....	<b>3</b>
<b>Introduction</b> .....	<b>6</b>
<b>Precautions for use</b> .....	<b>7</b>
<b>Precautions for installation</b> .....	<b>8</b>
<b>Features</b> .....	<b>9</b>
<b>Supported remote cameras</b> .....	<b>9</b>
<b>Parts and their functions</b> .....	<b>10</b>
Control panel .....	10
Rear panel .....	14
<b>Connections</b> .....	<b>15</b>
Examples of IP connections .....	15
Examples of serial connections .....	17
<b>Basic operations of the unit</b> .....	<b>18</b>
<b>How to turn on and off the power of the remote cameras</b> .....	<b>19</b>
How to turn on the power of the remote cameras .....	19
How to turn off the power of the remote cameras .....	20
<b>Selecting a camera group</b> .....	<b>21</b>
<b>Selecting a remote camera</b> .....	<b>22</b>
<b>Status screen</b> .....	<b>23</b>
Displaying and operating the status screen .....	23
<b>Basic operations for the menus</b> .....	<b>24</b>
Displaying menus and the menu configuration .....	24
<b>Network settings of the unit</b> .....	<b>27</b>
<b>Settings for connecting with the remote cameras</b> .....	<b>29</b>
Setting the connection types (serial/IP/no connection) for remote cameras .....	30
Setting the IP addresses automatically (auto IP setting) .....	30
Manually setting the connection destination IP addresses (remote cameras) and port number .....	35
Set the user account of the camera to be connected .....	35
Initializing the connection destination IP addresses set on the unit .....	36
<b>Menu</b> .....	<b>37</b>
Menu group .....	37
PAINT .....	38
FUNCTION .....	46
MAINTENANCE .....	53
PMEM .....	63
SYSTEM .....	67
<b>Setup Software</b> .....	<b>73</b>
Installing the software .....	73
Configuring the settings of the personal computer .....	73
Settings for connecting with the remote cameras .....	74
<b>Messages</b> .....	<b>82</b>
<b>Troubleshooting</b> .....	<b>83</b>
<b>Appearance</b> .....	<b>84</b>
<b>Specifications</b> .....	<b>85</b>
<b>Control interface for external devices</b> .....	<b>86</b>
<b>Index</b> .....	<b>88</b>

# Introduction

## ■ Overview

This unit is a remote camera controller for controlling remote camera (sold separately).  
It can be used to control up to 200 remote cameras when IP connections are used, and up to 5 remote cameras when serial connections are used.

## ■ Required personal computer environment

For the software used with the unit, use a personal computer specified on the following website.  
<https://pro-av.panasonic.net/>

## ■ Disclaimer of warranty

IN NO EVENT SHALL Panasonic Connect Co., Ltd. BE LIABLE TO ANY PARTY OR ANY PERSON, EXCEPT FOR REPLACEMENT OR REASONABLE MAINTENANCE OF THE PRODUCT, FOR THE CASES, INCLUDING BUT NOT LIMITED TO BELOW:

- (1) ANY DAMAGE AND LOSS, INCLUDING WITHOUT LIMITATION, DIRECT OR INDIRECT, SPECIAL, CONSEQUENTIAL OR EXEMPLARY, ARISING OUT OF OR RELATING TO THE PRODUCT;
- (2) PERSONAL INJURY OR ANY DAMAGE CAUSED BY INAPPROPRIATE USE OR NEGLIGENT OPERATION OF THE USER;
- (3) UNAUTHORIZED DISASSEMBLE, REPAIR OR MODIFICATION OF THE PRODUCT BY THE USER;
- (4) INCONVENIENCE OR ANY LOSS ARISING WHEN IMAGES ARE NOT DISPLAYED, DUE TO ANY REASON OR CAUSE INCLUDING ANY FAILURE OR PROBLEM OF THE PRODUCT;
- (5) ANY PROBLEM, CONSEQUENTIAL INCONVENIENCE, OR LOSS OR DAMAGE, ARISING OUT OF THE SYSTEM COMBINED BY THE DEVICES OF THIRD PARTY;
- (6) ANY INCONVENIENCE, DAMAGES OR LOSSES RESULTING FROM ACCIDENTS CAUSED BY AN INADEQUATE INSTALLATION METHOD OR ANY FACTORS OTHER THAN A DEFECT IN THE PRODUCT ITSELF;
- (7) LOSS OF REGISTERED DATA CAUSED BY ANY FAILURE;
- (8) ANY DAMAGE OR CLAIMS DUE TO LOSS OR LEAKAGE OF IMAGE DATA OR SETTING DATA SAVED ON THIS UNIT OR PERSONAL COMPUTER.

## ■ Network security

This unit also has functions which are used when it is connected to a network.  
Using the unit when it is connected to a network may possibly give rise to the following.

- (1) Leakage or disclosure of information transmitted via this unit
- (2) Unauthorized use of this unit by a third person with malicious intent
- (3) Interference or stoppage of this unit by a third person with malicious intent

It is your responsibility to take sufficient network security measures such as those described below to protect yourself against the above risks. Panasonic does not accept any responsibility for damage of this type.

- Use this unit in a network secured by a firewall, etc.
- If this unit is used in a system with a personal computer connected, make sure that checks for and removal of computer viruses and malicious programs are implemented regularly.

Also observe the following points.

- Do not install the unit in a location where the unit, cables, and other parts may be easily damaged.

## ■ User authentication

In order to protect device settings from exposure on the network, when connecting to a network, please enable user authentication to restrict access as appropriate.

## ■ Restrictions on use

It is recommended that the remote operation panel and all devices to be used with the remote operation panel be connected to the same network segment.

Events related to settings of network devices may occur if devices are connected to different segments, so verify operation carefully before placing devices into service.

## ■ Upgrade software

You can obtain the upgrade software from Service and Support on the following website.  
<https://pro-av.panasonic.net/>

For the upgrade procedure, refer to the instructions included with the download file.

## ■ File types handled by the unit

Camera configuration file	Configuration file data for the remote cameras.
RP configuration file	Configuration file especially for AW-RP60.

# Precautions for use

Observe the following in addition to the information included in “Read this first!”.

## Handle carefully

Do not drop the product, or subject it to a strong impact or vibration.  
Do not carry or move the product by the PAN/TILT lever or a dial.  
Doing so may cause a failure or accident.

## Use the product in an ambient temperature of 0 °C to 40 °C (32 °F to 104 °F)

Exposure to temperatures below 0 °C (32 °F) or above 40 °C (104 °F) could adversely affect Internal components.

## Power off before connecting or disconnecting cables

Before connecting or disconnecting the cables, be sure to turn the power off.

## Avoid humidity and dust

Avoid using the product in a very humid or dusty place because a lot of humidity and dust will cause damage to the internal parts.

## Cleaning

Turn the power off and wipe the product with a dry cloth. To remove stubborn dirt, dip a cloth into a diluted solution of kitchen detergent (neutral detergent), wring it out well, and wipe the product gently. Then, wipe the product with a cloth dampened with water. Finally, wipe the product with a dry cloth.

### Notes

- Avoid using benzine, paint thinners and other volatile fluids.
- If a chemical cleaning cloth is to be used, carefully read through the precautions for its use.

## Avoid open flames

Do not place candles and other sources open flame near the unit.

## Avoid exposure to water

Make sure that the unit is not directly exposed to water. Exposure to water could damage it.

## Disposal of the unit

When the unit has reached the end of its service life and is to be disposed of, ask a qualified contractor to dispose of the unit properly in order to protect the environment.

## LCD panels

The pixels of the LCD panel are controlled to obtain high precision with 99.99% of the effective pixels. This leaves less than 0.01% of pixels that may not light or may remain on all the time. This is normal and will have no effect on the images you shoot.

There may be some unevenness on the screen depending on the image displayed.

Wiping or rubbing the LCD screen with a rough cloth may damage it.

LCD response time and brightness vary with operating temperature.

When the unit is left in a high-temperature and high-humidity location for prolonged periods, the LCD panel characteristics may change and result in uneven image quality.

Due to the characteristics of LCD panels, prolonged display of bright still images or prolonged operation in high-temperature or high-humidity environments may result in residual images, luminance reduction, burn-in, banding, or panel defects and degradation that result in areas of permanently changed brightness.

In addition, avoid prolonged continuous use in the following types of environments.

- Confined areas with high temperature and humidity
- Near the exhaust vent of air conditioning equipment, etc.

Prolonged use involving the images and environments described above will accelerate deterioration of the LCD panel over time.

To prevent deterioration over time and its related phenomena, we recommend the following.

- Do not display bright still images for prolonged periods.
- Lower the brightness.
- Turn off the power of the unit (and the power of the hub) when the unit is not in use.

Residual images will gradually disappear as different images are displayed.

## PoE power supply

If both an external DC power supply and a PoE power supply are connected, the power supply from the external DC power supply will be used. If the external DC power supply is disconnected from a state where both power supplies were connected, the unit will restart automatically.

Use a category 5e cable or higher for the PoE connection. The maximum cable length for the connection between the power supply device and the unit is 100 m (328.1 ft). Using a cable that is category 5 or lower may result in decreased power supply performance.

When a personal computer that supports Gigabit Ethernet and a PoE injector are connected via a straight LAN cable, the unit may not be recognized by the personal computer. In such cases, connect the unit to the personal computer via a cross cable (or cross connection).

# Precautions for installation

In addition to the safety precautions given in “Read this first!”, also observe the following instructions.

Be sure to ask your dealer to perform the installation and connection work for the unit.

### Connecting a power supply

- Insert the DC plug for the external DC power supply all the way in until it locks into place.

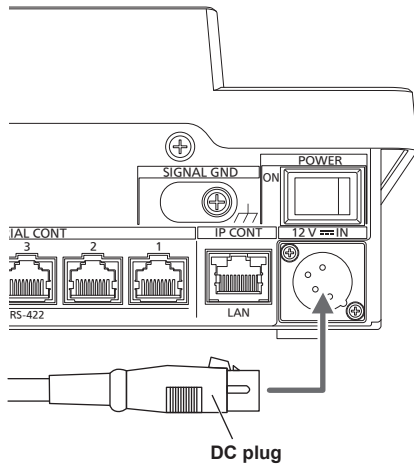

- When the unit will not be used for a long time, turn off the power switch and remove the DC plug for the external DC power supply to save power.

### Do not allow any foreign objects to enter inside the unit

- Allowing water, metal items, food or drink, or other foreign objects to enter inside the unit may cause a fire or electric shock.

### Installation location

- This unit is designed for indoor use only.
- Install and use the unit in a stable location.
- Avoid installing the unit where it will be exposed to direct sunlight.
- Installing the unit in a location with a lot of humidity, dust, or vibration may result in a failure.



# Features

---

## IP connections and serial connections supported

### IP connections

- Up to 200 remote cameras\*1 can be controlled via a network hub (switching hub).
  - The unit's auto IP setting function can be used to automatically assign and control the IP addresses of the remote cameras\*1.
- \*1: Supported cameras:**  
**AW-HE35, AW-HE38, AW-HE40, AW-HE42, AW-HN38, AW-HN40, AW-UE70, AW-UN70**
- One remote camera can be simultaneously controlled from up to 5 units.

### Serial connections

- Up to 5 remote cameras can be connected.

## Easy to operate the remote cameras

- The unit is equipped with dedicated levers, buttons, and dials for performing pan, tilt, zoom, and focus operations. Also, it has a control to adjust the speed of pan, tilt and zoom. Camera angle adjustment can be performed quickly and reliably.
- The unit is equipped with an AWB button and ABB button for executing automatic adjustment of the white balance and black balance.
- Rapid call up operations are available for shooting environments that frequently use presets. Also, the speed at which a remote camera moves to a preset position (PRESET SPEED) can be memorized for each preset number of the unit. Thus, a remote camera can be operated at a different speed depending on the preset number in accordance with operation, enabling various image directing.
- The unit is equipped with PoE\*2, eliminating the need for additional power supply cabling. Connecting the unit to a network device that supports the PoE standard (IEEE802.3af compliant)\*3 eliminates the need for power supply cabling on the unit.

### Notes

- If both an external DC power supply and a PoE power supply are connected, the power supply from the external DC power supply will be used. If the external DC power supply is disconnected from a state where both power supplies were connected, the unit will restart automatically.
- Use a category 5e cable or higher for the PoE connection. The maximum cable length for the connection between the power supply device and the unit is 100 m (328.1 ft). Using a cable that is category 5 or lower may result in decreased power supply performance.
- When a personal computer that supports Gigabit Ethernet and a PoE injector are connected via a straight LAN cable, the unit may not be recognized by the personal computer. In such cases, connect the unit to the personal computer via a cross cable (or cross connection).

\*2: Power over Ethernet. Referred to as "PoE" in this manual.

\*3: For details on PoE power supply devices for which operation has been verified, consult your local dealer.

---

## Supported remote cameras

### ● Integrated Camera

AW-HE35, AW-HE38, AW-HE40, AW-HE42, AW-HN38, AW-HN40, AW-UE70, AW-UN70

For details, visit the following website.

<https://pro-av.panasonic.net/>

# Parts and their functions

## Control panel

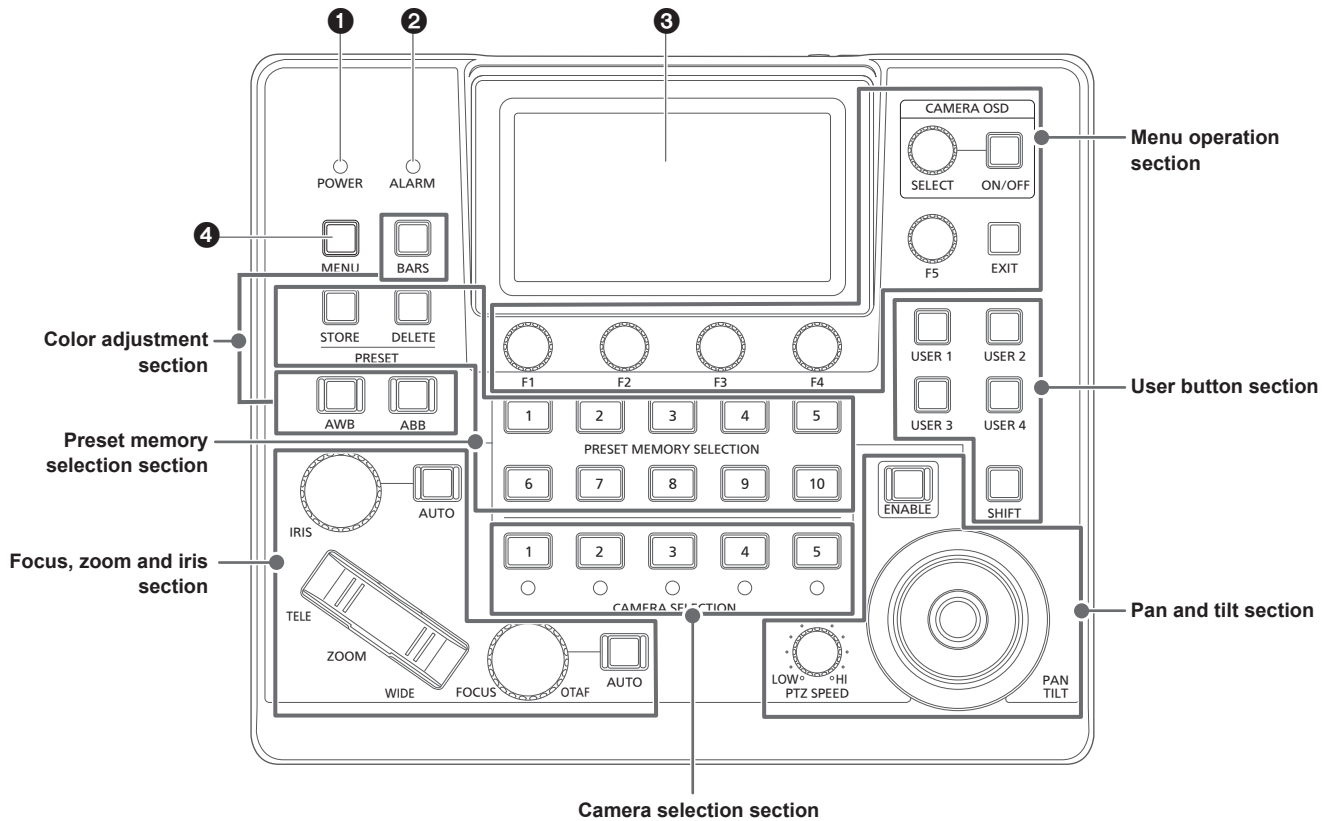

### 1 POWER indicator [POWER]

This turns on when the POWER switch (38) on the rear panel is set to ON while power is supplied.

### 2 ALARM indicator [ALARM]

This turns on when an alarm has been received from the selected remote camera.

### 3 LCD panel

Displays the status screen or menu.

### 4 MENU button [MENU]

When you press the MENU button, the menu will be displayed on the LCD panel. This is lit while the menu is displayed.

### 6 F5 dial [F5] (menu operation dial)

When a menu screen is displayed on the LCD panel, turn the dial to find the menu and then press it to select.

### 7 F1 dial [F1], F2 dial [F2], F3 dial [F3], F4 dial [F4] (menu operation dials)

Use these dials to manipulate the setting values displayed on the LCD panel of the unit. Turn F1 to F4 dials to select setting values, etc. When the status screen is displayed, use them to manipulate the item values displayed in the lower part of the LCD panel. When a menu screen is displayed, use them to manipulate the selected menu item values.

### 8 CAMERA OSD ON/OFF button [CAMERA OSD ON/OFF]

Use this to switch the CAMERA OSD ON or OFF.

### 9 EXIT button [EXIT]

When you press the EXIT button while a menu screen is displayed on the LCD panel, the screen will return to the previous menu. When the status screen is displayed, if you press the EXIT button while manipulating the items that are allocated to the F1 through F4 dials, the operation of the dial will be canceled.

## Menu operation section

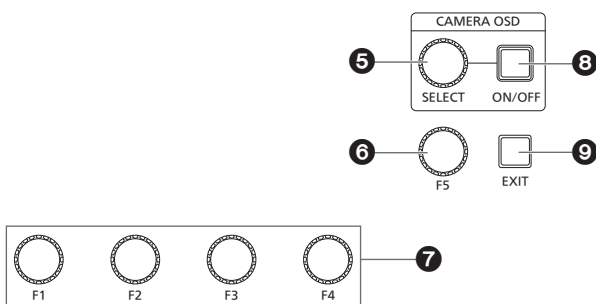

### 5 CAMERA OSD SELECT dial [CAMERA OSD SELECT]

When the CAMERA OSD ON/OFF button is lit, turn the dial to find the menu and then press it to select.

Camera selection section

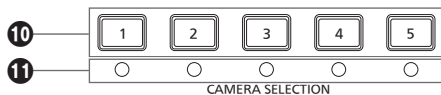

10 Camera selection buttons

[CAMERA SELECTION 1 to 5]

Use these to select the camera number belonging to the camera group that was set on the status screen.

- Off** : The camera is not being selected
- On (green)** : G\_TALLY is ON and the camera is not being selected
- On (red)** : R\_TALLY is ON and the camera is not being selected
- On (amber)** : The camera is being selected (The TALLY of the selected camera is displayed on the LCD panel.)

11 Camera status LED

These indicate the statuses of the remote cameras assigned to camera selection buttons [1] to [5].

For details, refer to "Selecting a remote camera" (page 22).

- Off** : Not connected
- On (amber)** : Camera standby
- On (green)** : Connected

Pan and tilt section

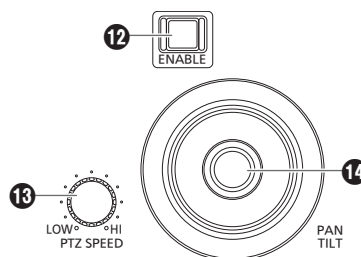

12 PAN/TILT / IRIS / ZOOM / FOCUS ENABLE button [ENABLE]

Use this to enable or disable operation of the PAN/TILT lever (14), IRIS dial (15), ZOOM button (16) and FOCUS dial (18).

- On (amber)** : Operation of the PAN/TILT lever, IRIS dial, ZOOM button and FOCUS dial is enabled.
- Off** : The operation is disabled.
- On (blue)** : Only operation of the IRIS dial is disabled (Operation of the PAN/TILT lever, ZOOM button and FOCUS dial is enabled.)

15 PTZ SPEED dial [PTZ SPEED]

Use this to adjust the operation speed variation amount for PAN/TILT lever (14) and ZOOM button (16) operation.

- Turned clockwise** : Operation is at a higher speed (HI)
- Turned counterclockwise** : Operation is at a lower speed (LOW)

14 PAN/TILT lever

Use this to control the direction in which the currently selected remote camera points.

The movement speed differs depending on the angle to which the PAN/TILT lever is moved.

**Moved left or right** : The camera points to the left or right.

**Moved toward you or away from you:**

The camera points up or down.

- When the [PAN DIR] menu or the [TILT DIR] menu is set to [REVERSE], it is possible to change the relationship between the direction of lever tilt and the direction the camera moves.

**Note**

- When turning on the power, do not touch until the status screen is displayed on the LCD panel.

**Focus, zoom and iris section**

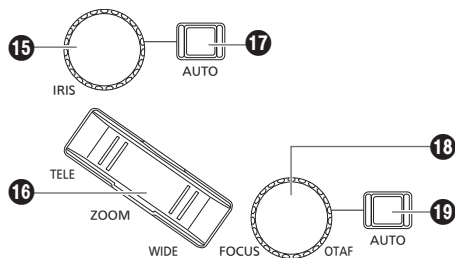

**19 Auto focus button [FOCUS AUTO]**

Use this to set focus control to "Auto (auto focus)".  
During auto focusing, operation of the FOCUS dial (18) and one-touch auto focus button (19) is disabled.

- On** : Auto focus
- Off** : Manual focus

**15 IRIS dial [IRIS]**

During manual iris (when the auto iris button (17) indicator is off), use this to manually control the lens iris.

During auto iris (when the auto iris button (17) indicator is on), use this to adjust the convergence level of the auto iris of the remote camera.

- Turned clockwise** : The lens iris opens (OPEN)
- Turned counterclockwise**: The lens iris closes (CLOSE)

- When the [IRIS DIR] menu is set to [REVERSE], it is possible to change the relationship between the direction of operation from OPEN to CLOSE.
- Hold down the dial to close the IRIS.

**16 ZOOM button [ZOOM]**

Use this to adjust the lens zoom.

The zooming speed changes depending on the extent to which the button is pressed.

**When the TELE side is pressed** : Moves toward the telephoto end.

**When the WIDE side is pressed** : Moves toward the wide-angle end.

- When the [ZOOM DIR] menu is set to [REVERSE], it is possible to change the relationship between the direction that the ZOOM button is pushed and the direction of the zoom operation of the lens.

**Note**

- When turning on the power, do not touch until the status screen is displayed on the LCD panel.

**17 Auto iris button [IRIS AUTO]**

Use this to set lens iris control to "Auto (auto iris)".

- On** : Auto iris
- Off** : Manual iris

**18 FOCUS dial [FOCUS]**

Use this to manually control the focus.

During auto focusing (when the auto focus button (19) indicator is on), operation is disabled.

- Turned clockwise** : The focus moves to the far end.
- Turned counterclockwise**: The focus moves to the near end.

- When the [FOCUS DIR] menu is set to [REVERSE], it is possible to change the relationship between the direction that the FOCUS dial is turned and the direction of the focus operation.

**One-touch auto focus button [OTAF]**

When the FOCUS dial is pressed during manual focusing (when the auto focus button (19) indicator is off), the auto focusing operation is performed to bring the subject into focus.

**Color adjustment section**



**20 BARS button [BARS]**

Use this to select the video signal output from the remote camera. Each press switches between the signal for the images shot by the camera and the color bar signal.

- Off** : Outputs the signal for the images shot by the camera
- On** : Outputs the color bar signal

**21 AWB button [AWB]**

Use this to execute automatic adjustment of the white balance and then register the adjustment result to memory A or B of the remote camera.

The AWB button indicator turns on during white balance adjustment and turns off when adjustment is successful.

The indicator blinks when adjustment is not possible.

- When automatic adjustment of the white balance ends, the R GAIN and B GAIN values become  $\pm 0$ .

**22 ABB button [ABB]**

Use this to execute automatic adjustment of the black balance.

When the button is pressed, adjustment is performed by automatically closing the iris.

The ABB button indicator turns on during black balance adjustment and turns off when adjustment is successful.

The indicator blinks when adjustment is not possible.

**Preset memory selection section**

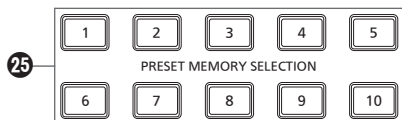

**23 STORE button [PRESET STORE]**

When holding down the STORE button, it will light up and a preset can be registered. When any of the preset memory selection buttons (25) is pressed in this condition, the registration of preset is complete. To cancel the preset registration, press the STORE button to turn it off.

**24 DELETE button [PRESET DELETE]**

When holding down the DELETE button, the preset can be deleted. When any of the preset memory selection buttons (25) is pressed in this condition, the deletion of preset is complete. After the preset is deleted, the button turns off. To cancel DELETE before executing it, press the button.

**25 Preset memory selection buttons**

**[PRESET MEMORY SELECTION 1 to 10]**

Use these to recall the preset of the preset group that was set on the status screen.

STORE button (23) is lit:

Use these to register the number of the preset in the preset group that was set in the status screen.

DELETE button (24) is lit:

Use these to delete the data of the preset in the preset group that was set in the status screen.

**User button section**

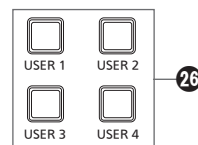

**26 USER buttons [USER 1] to [USER 4]**

Use these to access the functions assigned to USER 1 to USER 4.

**Off** : The function is disabled.

**On** : The function is enabled.

**27 SHIFT button [SHIFT]**

When the button is lit, USER buttons 1 to 4 change to USER buttons 5 to 8.

The USER 5 to 8 are displayed in the USER settings on the status screen.

Rear panel

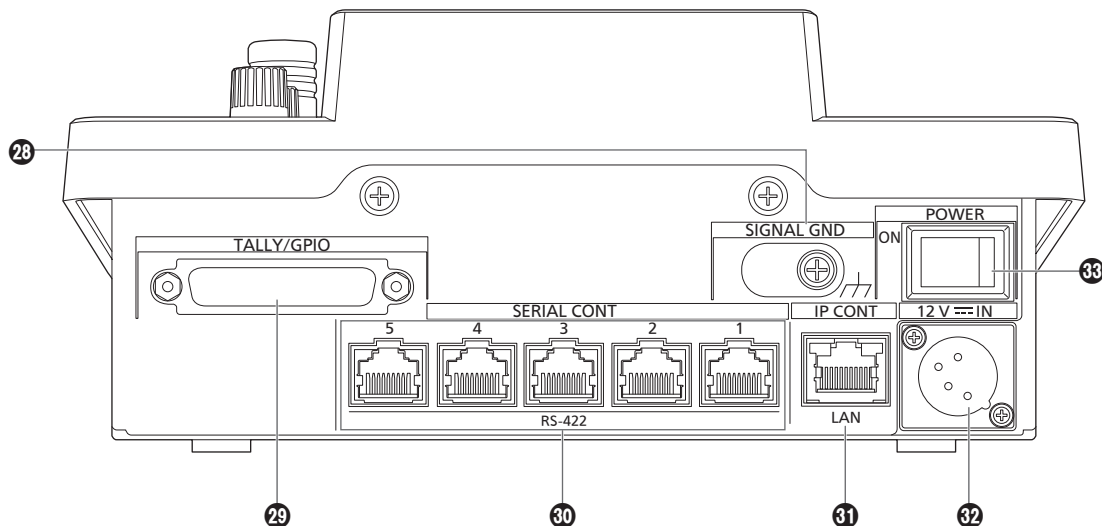

**28 Grounding terminal [SIGNAL GND]**

Connect this to the system ground.

**29 TALLY/GPIO connector [TALLY/GPIO]**

**JST: JBY-25S-1A3F(LF) (SN)**

Connect an external device to this connector to receive tally information or send the camera selection status. Use a shielded cable to connect to the connector.

**30 SERIAL CONT 1 to 5 connectors [SERIAL CONT 1 to 5] (RJ-45)**

Connect remote cameras that support a serial connection to these connectors with LAN cables.

Connect them with straight cables (category 5e or better shielded cable).

For details, refer to "Connections" (pages 15 to 17).

**Note**

- Do not connect cables for PoE power supply to these connectors.

**31 IP CONT connector [IP CONT] (RJ-45) (10BASE-T/100BASE-TX)**

Connect a remote camera or computer that supports an IP connection to this connector with a LAN cable.

When directly connecting a device to the unit, use a crossover cable (category 5e or better shielded cable).

When connecting via a hub (switching hub) etc., use a straight cable or a cross cable (category 5e cable).

For details, refer to "Connections" (pages 15 to 17).

**32 DC IN socket [12V IN] (DC 12 V) (XLR connector)**

Connect an external DC power supply to this connector.

- Use a DC cable with a length of max. 2 m (6.6 ft) (when using an AWG16 cable).

**External DC power supply**

Connect after making sure that the output voltage of the external DC power supply is compatible with the rated voltage of the camera.

Select an output amperage for the external DC power supply with a margin above the total amperage of the connected devices.

The total amperage of connected devices can be calculated with the following formula.

**Total power consumption ÷ voltage**

When the power of the camera is turned on, inrush current is generated. Insufficient power supply when turning on the power may cause a malfunction. We recommend that you use an external DC power supply that can assure double the capacity of the total power consumption of the camera and connected devices that are turned on by interlock when the power of the camera is turned on (such as lenses, wireless microphone receivers).

- Make sure of the pin alignment of the DC output terminal of the external DC power supply and the camera DC IN connector, and connect the polarity correctly.

If the +12 V power supply is mistakenly connected to the GND terminal, it may cause fire or malfunction.

12V IN	
1	GND
2	—
3	—
4	+12V
HA16RA-4P (77) Hirose Electric Co.	

**33 POWER switch [POWER]**

When the POWER switch is set to the ON position, the POWER indicator (●) lights, and the unit can be operated.

# Connections

## Examples of IP connections

### ■ IP connections for remote cameras

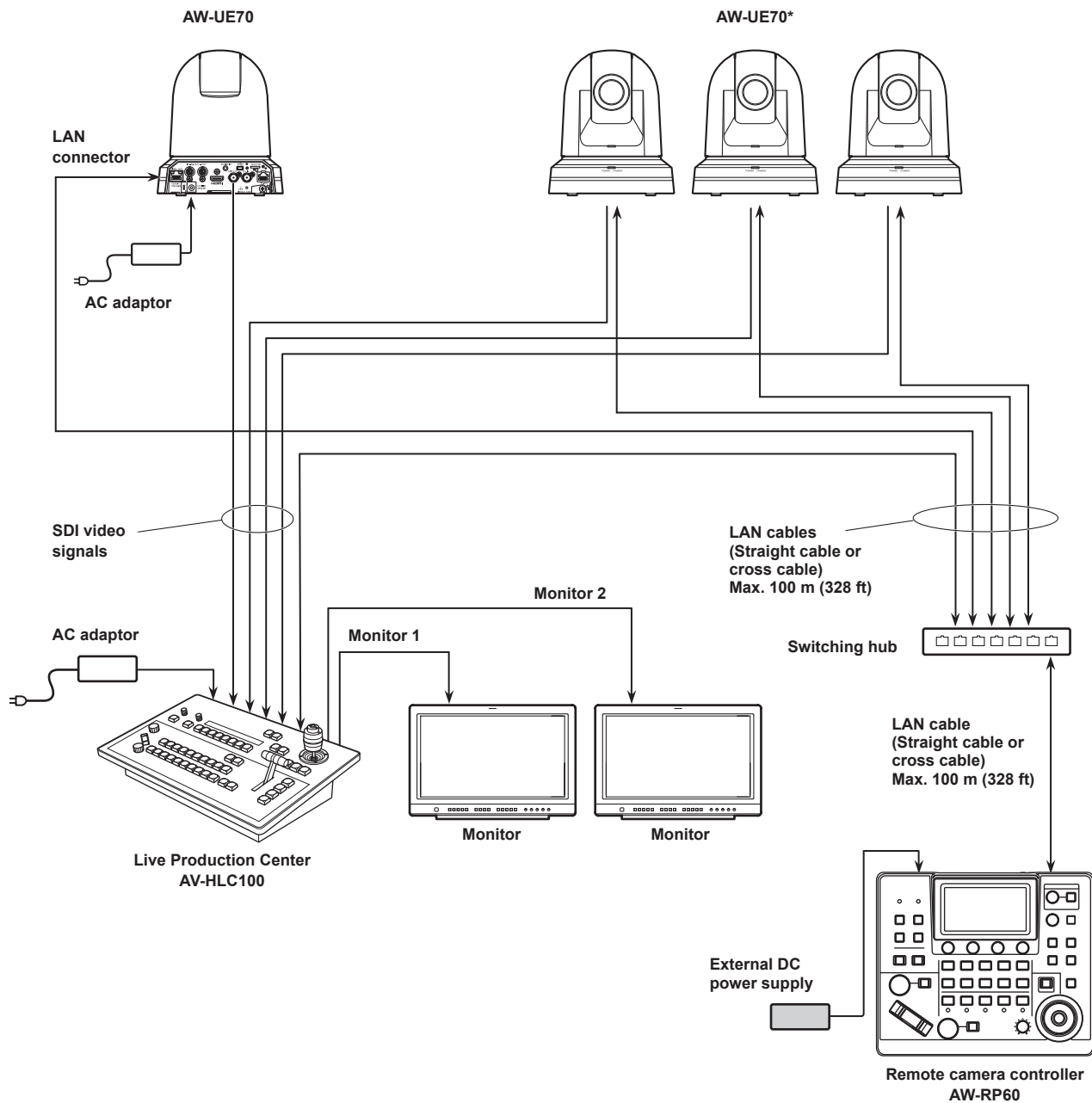

\*: The AC adaptor is not shown in the above figure.

- Use a category 5e cable for the LAN cable.
- It is possible to have a mixture of remote cameras connected via serial connections and remote cameras connected via IP connections.
- A total of up to 200 remote cameras connected via IP connections and serial connections can be registered as control destinations to one unit.

■ IP connections for multiple units and remote cameras

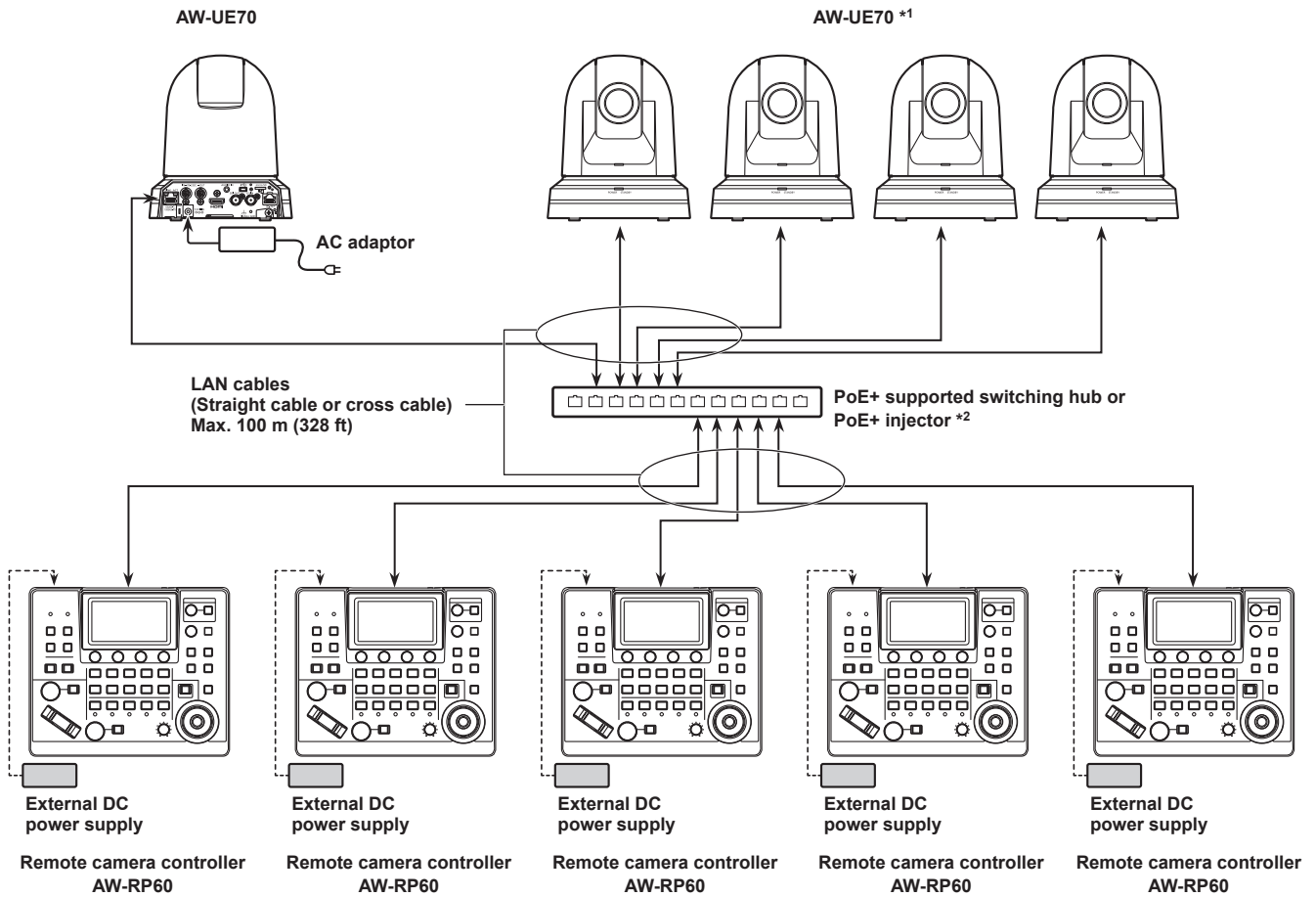

\*1: The AC adaptor is not shown in the above figure.

\*2: Power can also be supplied to the AW-RP60 from a PoE supported switching hub, PoE injector, PoE+ supported switching hub, or PoE+ injector.

- Use a category 5e cable for the LAN cable.
- One remote camera can be simultaneously controlled from up to 5 units. (When IP connection)

■ IP connection for one unit and one remote camera

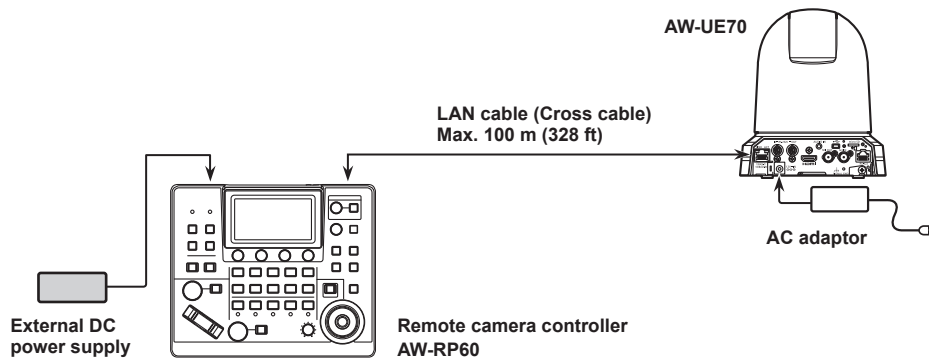

- Use a cross cable (category 5e cable) for the LAN cable.
- When connecting to any camera other than an AW-UE70, refer to the operating instructions for the camera.



Examples of serial connections

Serial connections for remote cameras

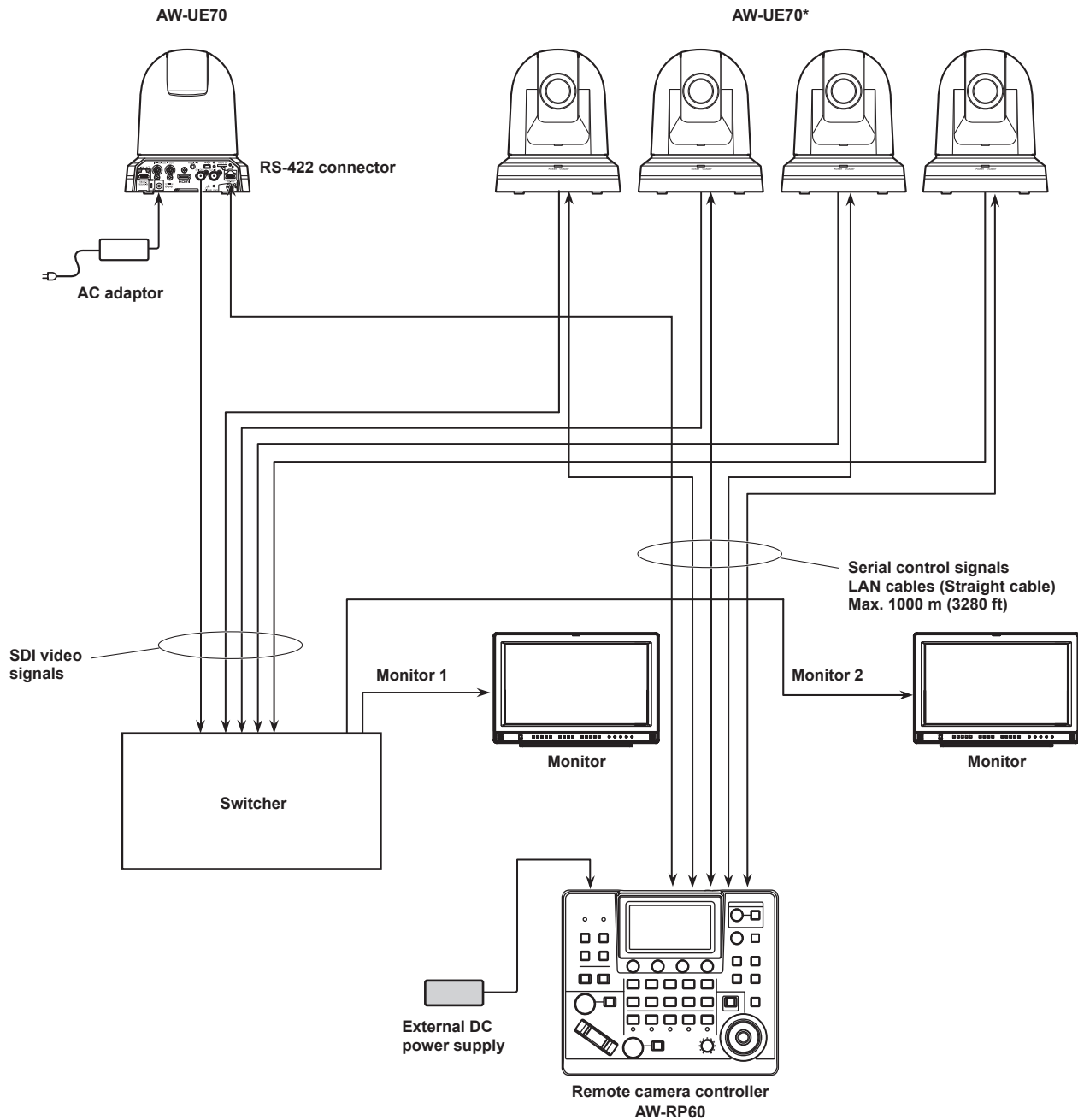

\*: The AC adaptor is not shown in the above figure.

- Use a straight cable (category 5e cable) for the LAN cable.
- When serial connections are used, up to 5 remote cameras can be connected to one unit.
- It is possible to have a mixture of remote cameras connected via IP connections and remote cameras connected via serial connections.
- A total of up to 200 remote cameras connected via IP connections and serial connections can be registered as control destinations to one unit.

# Basic operations of the unit

## 1. Turn on the unit's power.

Set the POWER switch to the ON position.

Power is supplied to the unit, and the POWER indicator turns on.

- When the [AUTO POWER] item in the [CAMERA] SYSTEM menu is set to [ON], the power of the remote camera turns on when the power of the unit is turned on.

However, this only works when the remote camera is in the standby state.

For details, refer to "How to turn on the power of the remote cameras" (page 19).

- Remote cameras are linked when the [CONNECT MODE] item in the [CONNECT SETTING] SYSTEM menu is set to either [Serial] or [LAN].

For details, refer to "Setting the connection types (serial/IP/ no connection) for remote cameras" (page 30).

## 2. Select a remote camera.

Press a [CAMERA SELECTION] button to select the remote camera to control from the unit.

## 3. Adjust the direction in which the remote camera points.

When the PAN/TILT / IRIS / ZOOM / FOCUS ENABLE button [ENABLE] indicator is on, use the PAN/TILT lever to adjust the direction in which the remote camera points.

### Note

- When turning on the power, do not touch until the status screen is displayed on the LCD panel.

## 4. Adjust the zoom.

When the PAN/TILT / IRIS / ZOOM / FOCUS ENABLE button [ENABLE] indicator is on, use the ZOOM button to adjust the lens zoom.

When the TELE side is pressed, the zoom is set to the telephoto mode, and when the WIDE side is pressed, it is set to the wide-angle mode.

### Note

- When turning on the power, do not touch until the status screen is displayed on the LCD panel.

## 5. Adjust the lens iris.

When the PAN/TILT / IRIS / ZOOM / FOCUS ENABLE button [ENABLE] indicator is on (amber), turn the IRIS dial to adjust the lens iris.

## 6. Adjust the focus.

When the PAN/TILT / IRIS / ZOOM / FOCUS ENABLE button [ENABLE] indicator is on, turn the FOCUS dial to adjust the lens focus.

When the one-touch auto focus button is pressed during manual focusing, the mode switches to auto focusing mode temporarily, and the subject is brought into focus automatically.

- OTAF (one-touch auto focus) is enabled for remote cameras which are equipped with the OTAF function.

## 7. Turn off the unit's power.

Set the POWER switch to the OFF position.

The unit's power is turned off, and the POWER indicator turns off.

- When the unit's power is turned off, the power of the connected remote cameras does not turn off.
- To turn off the power of the remote cameras, select [ALL OFF] or [GRP OFF] in the [CAM POWER] item of the [CAMERA] SYSTEM menu, and execute.

For details, refer to "How to turn off the power of the remote cameras" (page 20).

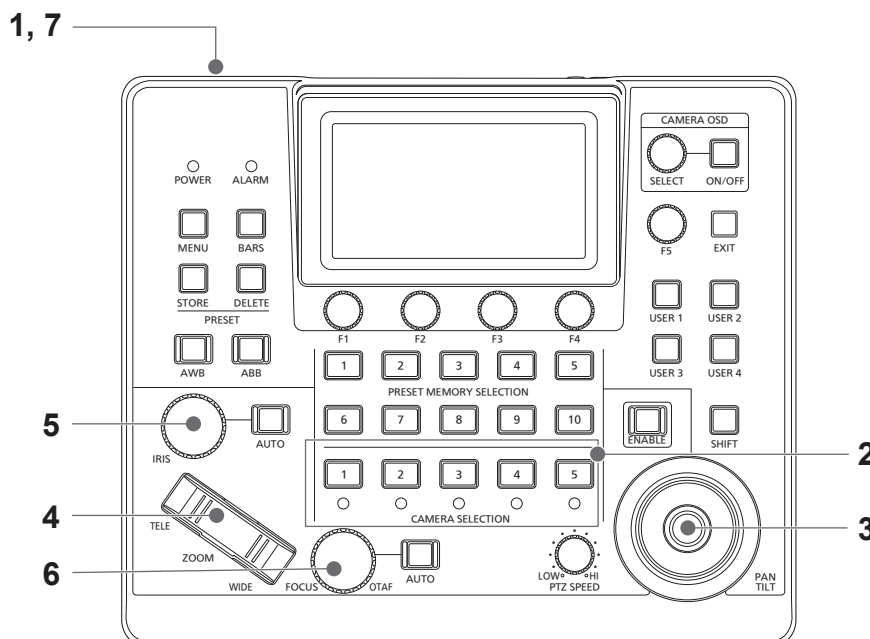

# How to turn on and off the power of the remote cameras

## How to turn on the power of the remote cameras

The power of the remote cameras in the standby state can be turned on from the unit.

There are the following methods of turning on the power.

- Turning on the power one camera at a time
- Turning on the power of the cameras simultaneously with the turning on of the unit's power
- Turning on the power of multiple cameras
  - ◇ Turning on the power of all the cameras
  - ◇ Turning on the power of the selected camera group

Each of these methods is described in turn below.

### Turning on the power one camera at a time

#### 1. Select the remote camera.

By holding down the applicable camera selection button [CAMERA SELECTION] for about 3 seconds, the name of the remote camera and the [ON (F2)] and [OFF (F3)] buttons are displayed on the LCD panel.

##### Note

- This operation is available when the status screen is being displayed.

#### 2. With the camera selection button held down, press the F2 dial.



### Turning on the power of the cameras simultaneously with the turning on of the unit's power

1. Press the [MENU] button.
2. Select the [CAMERA] SYSTEM menu to display the [AUTO POWER] item.

C001 : AW-UE70			TALLY : <span style="color: red;">■</span> <span style="color: green;">■</span>
<b>CAMERA</b>			
CAM POWER	AUTO POWER	CAM LOCK	
NON	ON	—	

#### 3. Turn the F2 dial to select [ON] and press the F2 dial.

The power of remote cameras whose setting in the [CAM1] to [CAM200] item in the [CONNECT SETTING] SYSTEM menu is set to either [Serial] or [LAN] turns on when the unit's power is turned on.

##### Note

- Depending on the number of cameras connected, it may take some time before you can operate the unit.

### Turning on the power of multiple cameras

1. Press the [MENU] button.  
Press the [MENU] button to light it.
2. Select the [CAMERA] SYSTEM menu to display the [CAM POWER] item.

C001 : AW-UE70			TALLY : <span style="color: red;">■</span> <span style="color: green;">■</span>
<b>CAMERA</b>			
CAM POWER	AUTO POWER	CAM LOCK	
NON	ON	—	

#### ■ Turning on the power of all the cameras

3. Turn the F1 dial to select [ALL ON] and press the F1 dial.

#### ■ Turning on the power of the selected camera group

3. Turn the F1 dial to select [GRP ON] and press the F1 dial.

## How to turn off the power of the remote cameras

The power of the remote cameras can be turned off from the unit. There are the following methods of turning off the power.

- Turning off the power one camera at a time
- Turning off the power of multiple cameras
  - ◇ Turning off the power of all the cameras
  - ◇ Turning off the power of the selected camera group

Each of these methods is described in turn below.

### Turning off the power one camera at a time

#### 1. Select the remote camera.

By holding down the applicable camera selection button [CAMERA SELECTION] for about 3 seconds, the name of the remote camera and the [ON (F2)] and [OFF (F3)] buttons are displayed on the LCD panel.

##### Note

- This operation is available when the status screen is being displayed.

#### 2. With the camera selection button held down, press the F3 dial.



### Turning off the power of multiple cameras

#### 1. Press the [MENU] button.

#### 2. Select the [CAMERA] SYSTEM menu to display the [CAM POWER] item.

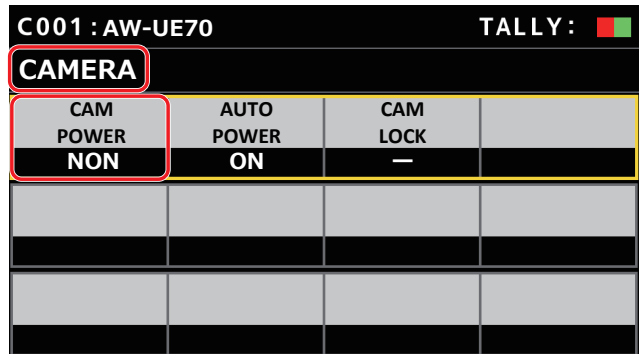

#### ■ Turning off the power of all the cameras

#### 3. Turn the F1 dial to select [ALL OFF] and press the F1 dial.

#### ■ Turning off the power of the selected camera group

#### 3. Turn the F1 dial to select [GRP OFF] and press the F1 dial.

## Selecting a camera group

This unit allows you to register up to 200 remote cameras as control targets by configuring the connection settings for each of the camera numbers CAM1 to CAM200. To select a remote camera to control from these cameras, you need to select the camera group to which it belongs beforehand.

Camera group	Camera numbers	Camera group	Camera numbers
1 to 5	CAM1 to CAM5	101 to 105	CAM101 to CAM105
6 to 10	CAM6 to CAM10	106 to 110	CAM106 to CAM110
11 to 15	CAM11 to CAM15	111 to 115	CAM111 to CAM115
16 to 20	CAM16 to CAM20	116 to 120	CAM116 to CAM120
21 to 25	CAM21 to CAM25	121 to 125	CAM121 to CAM125
26 to 30	CAM26 to CAM30	126 to 130	CAM126 to CAM130
31 to 35	CAM31 to CAM35	131 to 135	CAM131 to CAM135
36 to 40	CAM36 to CAM40	136 to 140	CAM136 to CAM140
41 to 45	CAM41 to CAM45	141 to 145	CAM141 to CAM145
46 to 50	CAM46 to CAM50	146 to 150	CAM146 to CAM150
51 to 55	CAM51 to CAM55	151 to 155	CAM151 to CAM155
56 to 60	CAM56 to CAM60	156 to 160	CAM156 to CAM160
61 to 65	CAM61 to CAM65	161 to 165	CAM161 to CAM165
66 to 70	CAM66 to CAM70	166 to 170	CAM166 to CAM170
71 to 75	CAM71 to CAM75	171 to 175	CAM171 to CAM175
76 to 80	CAM76 to CAM80	176 to 180	CAM176 to CAM180
81 to 85	CAM81 to CAM85	181 to 185	CAM181 to CAM185
86 to 90	CAM86 to CAM90	186 to 190	CAM186 to CAM190
91 to 95	CAM91 to CAM95	191 to 195	CAM191 to CAM195
96 to 100	CAM96 to CAM100	196 to 200	CAM196 to CAM200

### Selecting a camera group

**1. Press the F2 dial on the status screen.**

The camera group [CAM GP] item is selected.

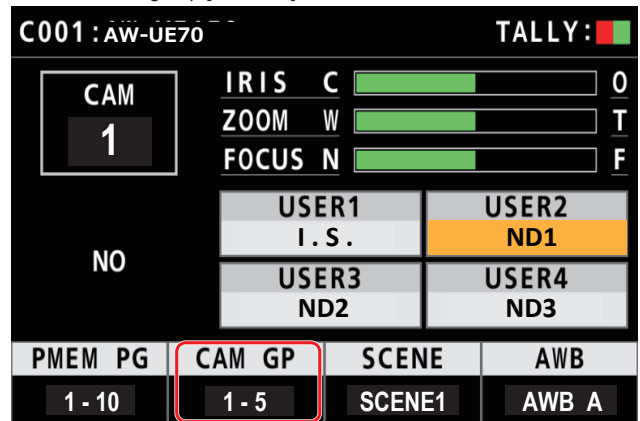

**2. Turn the F2 dial to select the camera group.**

**3. Press the F2 dial.**

The camera group will be selected.

## Selecting a remote camera

You can press a camera selection button [CAMERA SELECTION] to select the remote camera to control.

When a camera selection button is pressed, the indicator of the pressed button turns on and the remote camera is selected.

The status of the lamp (camera status LED) below each button indicates the status of the remote camera that is allocated to the camera selection button [1] to [5].

### ● Camera status LED and remote camera status

LED status	Remote camera status	Connection between unit and remote camera
Off	<ul style="list-style-type: none"> <li>The connection type of the corresponding camera number is set to [NON].</li> <li>Power is not being supplied to the remote camera.</li> </ul>	IP connection/ serial connection
On (amber)	The remote camera is in the standby state. Turn the power on as described in "How to turn on the power of the remote cameras" (page 19).	IP connection/ serial connection
On (green)	The unit is connected to the remote camera.	IP connection/ serial connection

## About camera selection buttons and camera status LED displays

### ● Camera status LED

LED status	Remote camera state
Off	Not connected
On (amber)	Camera standby
On (green)	<ul style="list-style-type: none"> <li>Camera connected</li> <li>Multiple AW-RP60s connected to the camera</li> </ul>

### ● Camera selection buttons

Button lighting status	Remote camera state
Off	Unselected
On (green)	G_TALLY ON (camera not selected)
On (red)	R_TALLY ON (camera not selected)
On (amber)	Selected <ul style="list-style-type: none"> <li>The camera also changes to this status if a camera with R/G_TALLY ON is selected.</li> <li>When a camera with R/G_TALLY ON is selected, the TALLY information is displayed on the LCD panel.</li> </ul>

# Status screen

## Displaying and operating the status screen

The status screen is displayed as the initial display when the power of the unit is turned on to start it up. The status screen displays the following information.

- Camera number
- IRIS, ZOOM, and FOCUS position
- Information about allocations to USER buttons

### 1. Display

The status screen is displayed as the initial display when the power of the unit is turned on to start it up. During operation, the status screen is displayed when all of the menu buttons in the menu operation section are off.

### 2. Select the remote camera to be controlled with the camera selection buttons [CAMERA SELECTION].

The selected camera button lights. When the camera selection button lights, you can control the remote camera from the unit.

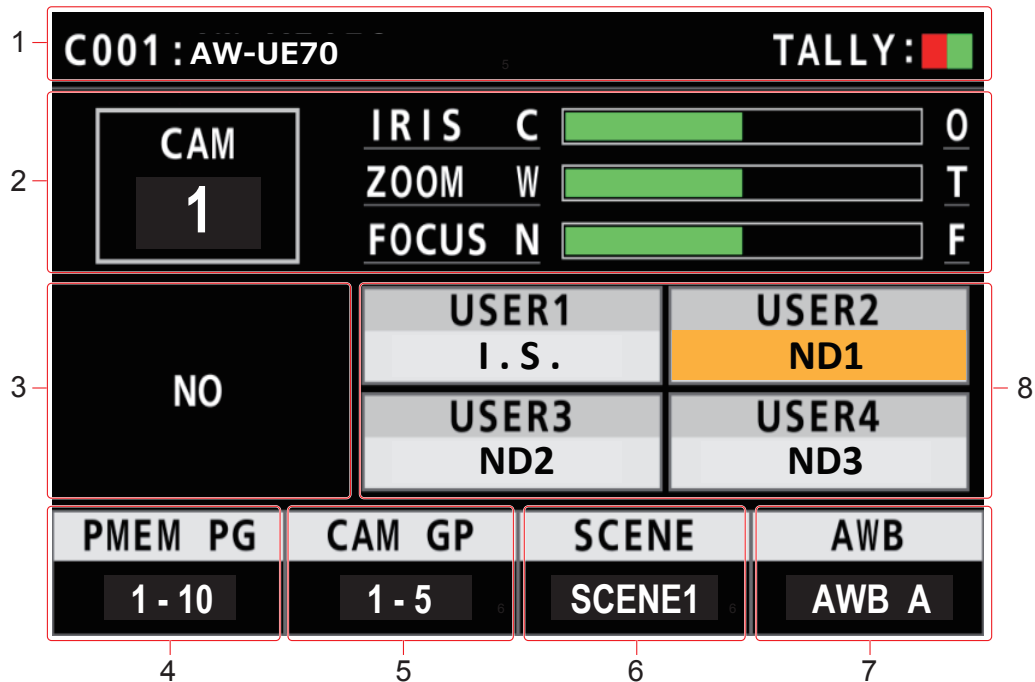

1	<b>Camera name, TALLY information</b>	Displays the currently selected camera name, and the status of TALLY (R_TALLY or G_TALLY). When the connection with the camera is via LAN, up to 10 characters of the name set on the camera can be displayed. Refer to the operating instructions for the camera for camera name settings.
2	<b>Camera number, lens position</b>	Displays the currently selected camera number, and the status of IRIS, ZOOM, and FOCUS.
3	<b>ALARM</b>	Displays alarm information notified from the currently selected camera.
4	<b>Preset memory group</b>	Displays the preset memory group number. The settings of the preset memory group you have selected can be assigned to the [PRESET MEMORY SELECTION] buttons.
5	<b>Camera group</b>	The camera group number is displayed. The settings of the preset memory group you have selected can be assigned to the [CAMERA SELECTION] buttons.
6	<b>SCENE</b>	Displays the SCENE number. You can switch the SCENE.
7	<b>AWB mode</b>	Displays the AWB mode. Use this to select the AWB mode.
8	<b>Information about function assignments</b>	The information about functions assigned and status to USER1 to USER4 is displayed. When the [SHIFT] button is lit, this indicates the assignment information and status of USER5 through USER8.

## Basic operations for the menus

### Displaying menus and the menu configuration

Use the [MENU] button and LCD panel on the unit to operate the menus.

Follow the procedure below to display the menu. The menu is displayed on the LCD panel (A) of the unit.

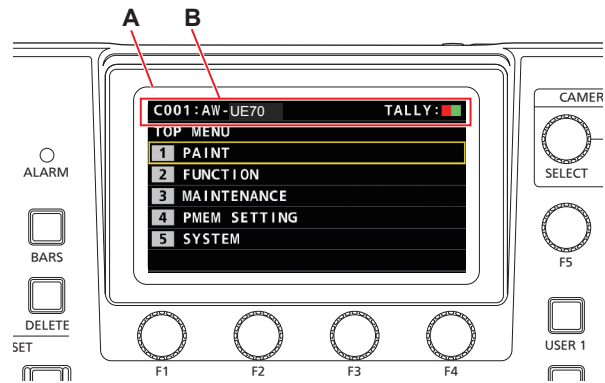

- A. LCD panel
- B. Displays the currently selected camera number and name, and the status of TALLY.



Operating procedure

1. Press the [MENU] button to display the MENU screen.

For details, refer to "Menu group" (page 37).

- Pressing the [MENU] button again will turn the menu display off and status screen is displayed.

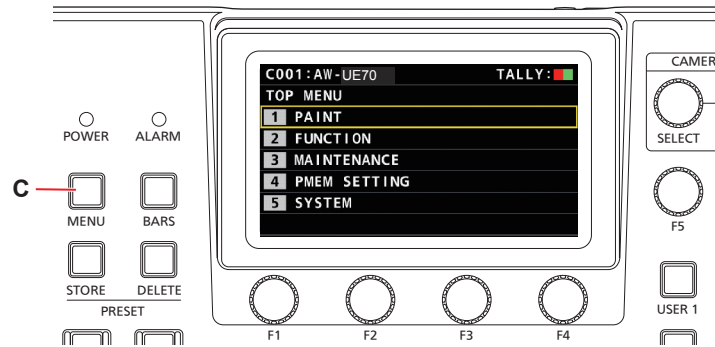

C. [MENU] button

2. Turn the [F5] dial to find the menu you want to set and then press the [F5] dial to select the menu.

or

Press a PRESET MEMORY SELECTION [1] to [5] button to select the menu you want to set.

(Select [MAINTENANCE] menu > [RP SETTING] > [MENU BT MODE], when [PMEM OFF] is set, you can select the menu above.)

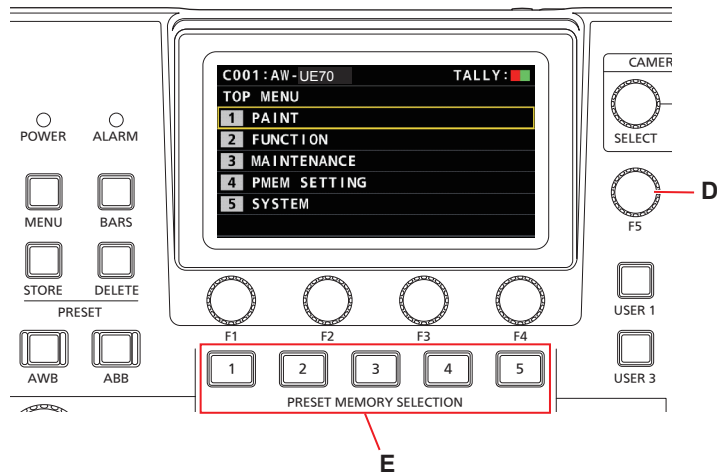

D. [F5] dial

E. PRESET MEMORY SELECTION [1] to [5] buttons

3. Turn the [F5] dial to find the item you want to set and then press the [F5] dial to select the menu.

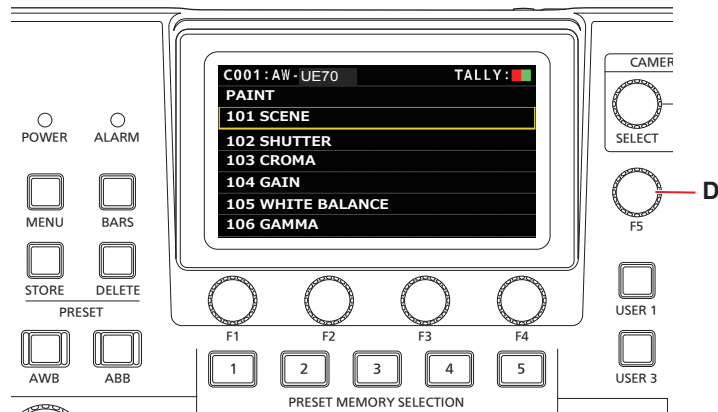

D. [F5] dial

4. Operate the [F1] to [F4] (F) menu operation dials to select the item you want to set and then press to confirm.

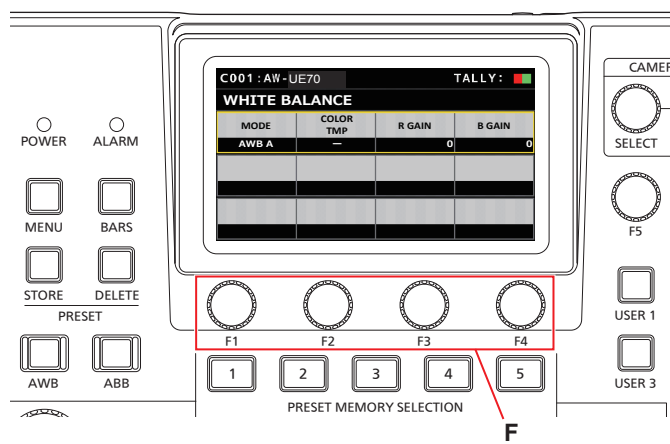

F. Menu operation dials

5. Operate the [F1] to [F4] (F) menu operation dials to change the setting values, etc. and then press to confirm.  
 Turn the dial at the same position as each item in the screen.  
 When the item you want to select is blinking, press the corresponding dial to select.

# Network settings of the unit

To control a remote camera connected via an IP connection from the unit, you need to set the network settings of the unit.

## Note

- Correct operation is not possible if the same IP address already exists in the same network. The message "IP Duplicate" may be displayed during start up, etc., when duplicate IP addresses have been detected. Set IP addresses that are not duplicates of any existing IP addresses.

## Setting the IP address of the unit

1. Press the [MENU] button.
2. Select the [RP IP SET] SYSTEM menu.
3. Operate the menu operation dials to select the [IP] item and then press to confirm.

C001 : AW-UE70			TALLY: 
RP IP SET			1/3
NETWORK SETTING			SAVE
STATIC			(push)
IP			
192	168	0	9
SUBNET			
255	255	255	0

- This is set to [192.168.0.9] by default.

4. Use the menu operation dials to set the IP address of the unit to one that is not a duplicate of that of another device.

Enter this in 4 blocks of numerals.

If [SAVE] in the first row is not executed, the changes are not updated.

- The "IP Duplicate" message is displayed when the connection destination IP address of the remote camera is duplicated, and it cannot be registered. Refer to the "Settable addresses" (page 28).

## Notes

- In order for the setting to take effect, the unit must be restarted. Turn off the unit's power, and then turn it back on.
- Consult the network administrator before setting the IP address.

## Setting the subnet mask

1. Press the [MENU] button.
2. Select the [RP IP SET] SYSTEM menu.
3. Operate the menu operation dials to select the [SUBNET] item and then press to confirm.

C001 : AW-UE70			TALLY: 
RP IP SET			1/3
NETWORK SETTING			SAVE
STATIC			(push)
IP			
192	168	0	9
SUBNET			
255	255	255	0

- This is set to [255.255.255.0] by default.

4. Use the menu operation dials to set the subnet mask of the unit.

Enter this in 4 blocks of numerals.

If [SAVE] in the first row is not executed, the changes are not updated.

- "Unavailable Subnetmask setting" is displayed if a value that cannot be set is entered. Refer to the "Settable addresses" (page 28).

## Note

- In order for the setting to take effect, the unit must be restarted. Turn off the unit's power, and then turn it back on.

**Setting the default gateway**

1. Press the [MENU] button.
2. Select the [RP IP SET] SYSTEM menu.
3. Operate the menu operation dials to select the [GATEWAY] item and then press to confirm.

C001 : AW-UE70		TALLY: <span style="color:red">■</span> <span style="color:green">■</span>	
RP IP SET		2/3	
GATEWAY			
192	168	0	1
PORT C1	PORT C2	PORT C3	PORT C4
61000	61002	61004	61006
PORT C5			
61008			

● This is set to [192.168.0.1] by default.

4. Use the menu operation dials to set the default gateway of the unit.

Enter this in 4 blocks of numerals.

If you did not execute [SAVE] at the first line of first screen (1/3), the content you have changed cannot be set.

**Note**

- In order for the setting to take effect, the unit must be restarted. Turn off the unit's power, and then turn it back on.

**Displaying the MAC address**

1. Press the [MENU] button.
2. Select the [RP IP SET] SYSTEM menu.
3. Operate the menu operation dials to select the [MAC ADDRESS] item and then press to confirm.

C001 : AW-UE70		TALLY: <span style="color:red">■</span> <span style="color:green">■</span>	
RP IP SET		3/3	
MAC ADDRESS			
**_**_**_**_**_**			

● The MAC address can only be displayed. It cannot be changed.

**Memo**

**Settable addresses**

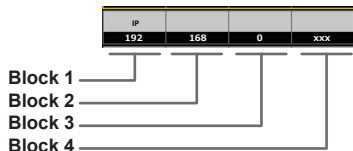

- For the IP address, you can set values within the following ranges.

<b>Block 1: 1 to 223</b>	<b>Block 2: 0 to 255</b>
<b>Block 3: 0 to 255</b>	<b>Block 4: 1 to 254</b>

However, [127.0.0.1] cannot be set even though it is within the above ranges.

- For the subnet mask, you can set values within the following ranges.

<b>Block 1: 0 to 255</b>	<b>Block 2: 0 to 255</b>
<b>Block 3: 0 to 255</b>	<b>Block 4: 0 to 255</b>

However, [0.0.0.0] and [127.0.0.1] cannot be set even though they are within the above ranges.

# Settings for connecting with the remote cameras

To control remote cameras from the unit and use the function to link the unit, you need to set the connection settings in advance. There are two ways of configuring the connection settings. You can either configure the settings on the unit or use the setup software to configure the settings. This section describes how to configure the settings on the unit. For details on how to use the setup software to configure the settings, refer to "Setup Software" (page 73).

### Notes

- All the remote cameras are set to the same IP address when they are shipped from the factory. Therefore, if multiple remote cameras left set to the factory default state are connected with IP connections and then operated from the unit, they will not operate properly.
- When another remote camera that is set to the same IP address as an existing remote camera is to be connected because, for example, the existing remote camera is being replaced, turn off the unit's power before making the connection. When the remote camera is connected without first turning off the unit's power, the remote camera may not operate properly.

### Link settings

Selecting one of the camera numbers CAM1 to CAM200 on the unit identifies the remote camera to control. When the remote camera you are attempting to control is connected via an IP connection, you need to set an IP address that is not a duplicate of that of each of the remote cameras and associate each IP address and each camera number on the unit beforehand in order to perform control. These association settings are referred to as "**link settings**" in this manual.

### Connection destination IP addresses

The IP address for the unit to identify the connection target (remote camera) is referred to as the "**connection destination IP address**" in this manual. One connection destination IP address is allocated for each of the remote cameras connected to the unit, from camera number CAM1 to CAM200, for a total of 200 addresses set in the unit. The connection destination IP address for each camera number can be viewed in [SYSTEM] > [MANUAL IP SET/USER AUTH] menu.

### Overview of related menus and operations

#### [SYSTEM] > [CONNECT SETTING]

Set the connection type (serial/IP/no connection) for the remote camera to be connected for each camera number.

#### [SYSTEM] > [AUTO IP SET] > [AUTO SET]

Use this menu when you want to configure the settings for linking with the remote cameras automatically. (Auto IP setting)  
There are the following two operation modes.

<b>RENEW</b>	Configures the link settings by the unit renewing the IP addresses set on the remote cameras.
<b>KEEP</b>	Configures the link settings by keeping the IP addresses set on the remote cameras and renewing the connection destination IP addresses set on the unit.

#### [SYSTEM] > [MANUAL IP SET/USER AUTH]

Use this menu when you want to check or manually change the connection destination IP address set for each camera number.

### Setting the connection types (serial/IP/ no connection) for remote cameras

#### 1. Set the connection types for camera numbers CAM1 to CAM200.

Display the menu items with [SYSTEM] > [CONNECT SETTING].

C001 :AW-UE70		TALLY: <span style="color:red">■</span> <span style="color:green">■</span>	
CONNECT SETTING		1/17	
CAM SEL	CONNECT MODE		
1	Serial		
CAM1	CAM2	CAM3	CAM4
Serial	NON	NON	NON
CAM5	CAM6	CAM7	CAM8
NON	NON	NON	NON

#### 2. Set with the F1 dial and F2 dial.

You can specify the camera number (F1 dial) and the connection type (F2 dial) in the first row.

The rows from the second and so on display the connection type for each camera number and you can set them.

The connection type flashes when the setting is changed, so then press the dial to confirm the change.

**NON** : No connection (factory default)

**Serial** : Serial connection

**LAN** : IP connection

- The SERIAL CONT connectors [1] to [5] for serial connections correspond to each of the camera numbers CAM1 to CAM5. The serial connection [Serial] setting cannot be selected for CAM6 to CAM200.

#### Note

- When performing the steps described in "auto IP setting" (pages 30 to 34), set the target camera number to [NON].

### Setting the IP addresses automatically (auto IP setting)

When "auto IP setting" is executed, the settings for linking between the remote cameras connected within the same subnet as the unit are configured automatically.

The following explanations are split into configuring the settings for the first time (when the remote cameras and switcher are in the factory default state) and introducing additional remote cameras into an environment in which IP connections are already in use.

#### When configuring the settings for the first time

##### <Overview of operation>

With [SYSTEM] > [AUTO IP SET], set the [AUTO SET] item to [RENEW], then the link is set by executing SETTING in [EXEC]. When the [AUTO SET] item is [RENEW], the unit first searches within the same subnet. After this, each detected remote camera is allocated a camera number in order.

At this time, each remote camera IP address is overwritten with the connection destination IP address value set for each camera number in the unit.

#### Example:

(1) IP addresses set for remote cameras A, B and C (factory default state).

**Remote camera A** : 192.168.0.10

**Remote camera B** : 192.168.0.10

**Remote camera C** : 192.168.0.10

(2) Connection types set on the unit ([SYSTEM] > [CONNECT SETTING])

**CAM1** : NON

**CAM2** : NON

**CAM3** : NON

(3) Connection destination IP addresses set on the unit ([SYSTEM] > [MANUAL IP SET/USER AUTH])

**CAM1** : 192.168.0.10

**CAM2** : 192.168.0.11

**CAM3** : 192.168.0.12

When the [AUTO SET] item is set to [RENEW] in this state, the IP addresses for remote cameras A to C are overwritten with the following values, and links are set with each of camera numbers CAM1 to CAM3.

**Remote camera A** : 192.168.0.10

**Remote camera B** : 192.168.0.11

**Remote camera C** : 192.168.0.12

#### Memo

The IP address allocated to the camera is the next number from the IP address of this unit.

If the IP address setting for this unit is 192.168.0.9, then allocations start from 192.168.0.10.

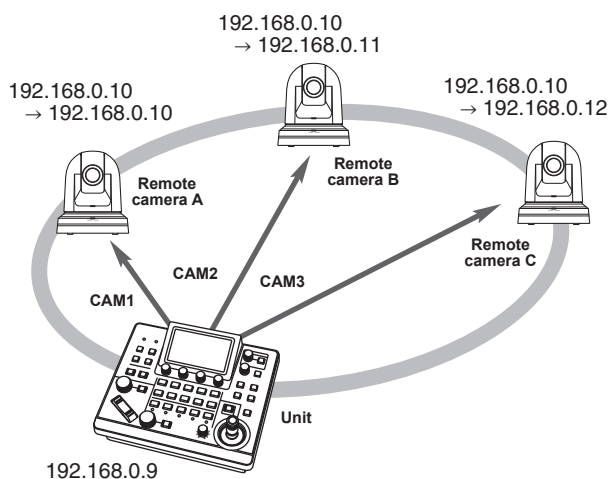

- For the camera numbers for which “auto IP setting” is executed, the connection type becomes [LAN] and the camera numbers are excluded from the setting targets the next time “auto IP setting” is executed.

<Operating procedure>

**Note**

- Before configuring the settings, check that the connection types of the remote cameras are [NON].

**Connection type settings**

SYSTEM menu → CONNECT SETTING → [CAM1] to [CAM200] items

1. Connect the remote cameras and unit to the network within the same subnet.
2. Select the [AUTO IP SET] SYSTEM menu, turn the F1 dial to set the [AUTO SET] item to [RENEW], then press the F1 dial.

C001 : AW-UE70			TALLY: <span style="color: red;">■</span> <span style="color: green;">■</span>
<b>AUTO IP SET</b>			<b>1/1</b>
AUTO SET	NEW	TOTAL	EXEC
RENEW			NON

The number of devices currently being managed by the unit (All remote cameras and the newly detected number of devices are displayed in [NEW] and [TOTAL].)

**NEW** : Newly detected cameras

**TOTAL** : The number of all devices currently being managed by the unit

3. Turn the [EXEC] (F4 dial) to select [SETTING], then press the F4 dial.

“Auto IP setting” starts.

The “AUTO IP SETTING” message is displayed while “auto IP setting” is being performed.

- The “COMPLETE” message is displayed when the entire process is successful.  
The remote cameras automatically reboot and restart with the newly configured IP addresses.  
The remote cameras can now be operated from the unit.
- The “SET UP ERR” message is displayed when IP address setting fails.  
The cause of the problem is likely to be a network malfunction.  
Check the connection status of the hub and LAN cables, and then retry the “auto IP setting” operation.

**When introducing additional remote cameras into an environment in which IP connections are already in use**

The settings can be configured using "auto IP setting" even when introducing additional remote cameras into an environment in which IP connections are already in use.

There are the following two methods.

1. Automatically changing the IP address set on the additional device to be introduced from the unit
2. Leaving the IP addresses of the additional devices to be introduced unchanged and automatically updating the connection destination IP addresses set on the unit

**■ Automatically changing the IP address set on the additional device to be introduced from the unit**

**<Overview of operation>**

By executing [RENEW] in the [AUTO SET] item of the [AUTO IP SET] SYSTEM menu, links are set.

With [RENEW], the unit first searches within the same subnet. Then, links are set between the newly detected remote cameras and camera numbers for which the connection type is set to [NON] on the unit. At that time, the IP addresses of the remote cameras are overwritten with the connection destination IP address values set on the unit.

**Example:**

(1) Operation is being performed with the three remote cameras A, B and C set to CAM1, CAM2 and CAM3, respectively.

(2) The new remote camera D (with the following IP address value) is added.

**Remote camera D : 192.168.0.10**

(3) Connection types set on the unit ([SYSTEM] > [CONNECT SETTING])

- CAM1 : LAN**
- CAM2 : LAN**
- CAM3 : LAN**
- CAM4 : NON**

(4) Connection destination IP address set on the unit ([SYSTEM] > [MANUAL IP SET/USER AUTH])

**CAM4 : 192.168.0.13**

When [RENEW] is executed in this state, the IP address of remote camera D is overwritten with the following value, and a link is set to the camera number CAM4.

**Remote camera D : 192.168.0.13**

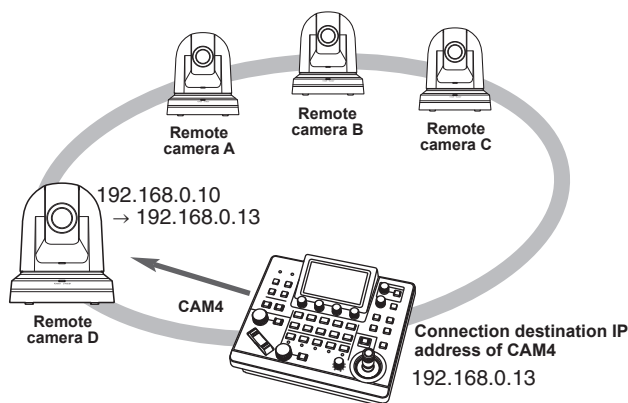

- When you connect a remote camera for which the IP address has been changed using a personal computer or other device after a link was set to the unit with auto IP setting and then execute [RENEW], the same IP address as was set when auto IP setting was executed the first time is set again for the corresponding camera.

**<Operating procedure>**

1. Connect the additional remote cameras to be introduced and the unit to the network within the same subnet.
2. Select the [AUTO IP SET] SYSTEM menu, turn the F1 dial to display [RENEW], then press the F1 dial.

C001 :AW-UE70			TALLY : <span style="color: red;">■</span> <span style="color: green;">■</span> <span style="color: blue;">■</span>
AUTO IP SET			1/1
AUTO SET	NEW	TOTAL	EXEC
RENEW			NON

The number of devices currently being managed by the unit (All remote cameras and the newly detected number of devices are displayed in [NEW] and [TOTAL].)

**NEW** : Newly detected cameras

**TOTAL** : The number of all devices currently being managed by the unit + Number of newly detected devices



**3. Set [EXEC] (F4 dial) to [SETTING], then press the F4 dial.**

“Auto IP setting” starts.

The “AUTO IP SETTING” message is displayed while “auto IP setting” is being performed.

- The “COMPLETE” message is displayed when the entire process is successful.  
The remote cameras are automatically rebooted, and they restart with the new IP addresses which were set.  
The remote cameras can now be operated from the unit.
- The “SET UP ERR” message is displayed when IP address setting fails.  
The cause of the problem is likely to be a network malfunction.  
Check the connection status of the hub and LAN cables, and then retry the “auto IP setting” operation.

**■ Leaving the IP addresses of the additional devices to be introduced unchanged and automatically updating the connection destination IP addresses set on the unit**

**<Overview of operation>**

By executing [KEEP] in the [AUTO SET] item of the [AUTO IP SET] SYSTEM menu, links are set.

With [KEEP], the unit first searches within the same subnet.

Then, links are set between the newly detected remote cameras and camera numbers for which the connection type is set to [NON] on the unit.

At that time, the IP addresses of the remote cameras are kept as is and the connection destination IP address values set on the unit are overwritten.

**Example:**

- (1) Operation is being performed with the three remote cameras A, B and C set to CAM1, CAM2 and CAM3, respectively.
- (2) The new remote camera D (with the following IP address value) is added.  
**Remote camera D : 192.168.0.20**
- (3) Connection types set on the unit ([SYSTEM] > [CONNECT SETTING])  
**CAM1 : LAN**  
**CAM2 : LAN**  
**CAM3 : LAN**  
**CAM4 : NON**
- (4) Connection destination IP address set on the unit ([SYSTEM] > [MANUAL IP SET/USER AUTH])  
**CAM4 : 192.168.0.13**

When [KEEP] is executed in this state, the IP address of remote camera D is not changed, the connection destination IP address set on the unit is overwritten with the following value, and a link is set to remote camera D.

**Connection destination IP address of CAM4:**  
192.168.0.20

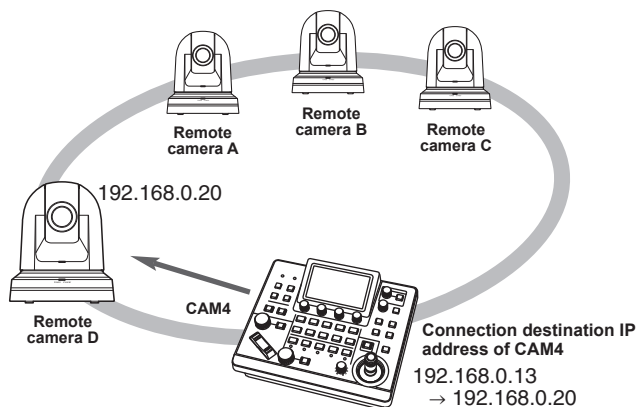

- If camera numbers for which the connection type is set to other than [Serial] include a camera number for which the connection destination IP address is set to the same value as the IP address of a detected remote camera, the connection destination IP address set on the unit is not updated. The connection destination IP address is kept as is and a link is set for the corresponding camera number and remote camera.

**Note**

- Set the subnet mask of the unit and remote camera to the same value. If the subnet masks are different, no operations using the network will be possible.

<Operating procedure>

1. Connect the additional remote cameras to be introduced and the unit to the network within the same subnet.
2. Select the [AUTO IP SET] SYSTEM menu, turn the F1 dial to display [KEEP], then press the F1 dial.

C001 : AW-UE70		TALLY: <span style="color: red;">■</span> <span style="color: green;">■</span>	
AUTO IP SET		1/1	
AUTO SET	NEW	TOTAL	EXEC
KEEP			NO?

The number of devices currently being managed by the unit (All remote cameras and the newly detected number of devices are displayed in [NEW] and [TOTAL].)

**NEW** : Newly detected cameras

**TOTAL** : The number of all devices currently being managed by the unit + Number of newly detected devices

3. Set [EXEC] (F4 dial) to [SETTING], then press the F4 dial.

"Auto IP setting" starts.

The "AUTO IP SETTING" message is displayed while "auto IP setting" is being performed.

- The "COMPLETE" message is displayed when the entire process is successful.  
The remote cameras can now be operated from the unit.
- The "IP Duplicate!" message is displayed when the IP address of an already running device and the IP address of a remote camera being added are the same, and the link setting is not made.  
Check the IP addresses of the additional remote cameras to be introduced, and then perform the "auto IP setting" operation again.
- The "SET UP ERR" message is displayed when IP address setting fails.  
The cause of the problem is likely to be a network malfunction.  
Check the connection status of the hub and LAN cables, and then retry the "auto IP setting" operation.

Memo

**Connection device detection**

- When the number of new devices detected by [RENEW] or [KEEP] exceeds the number of devices that can be registered (200 remote cameras), "C/S OVER!" appears.  
Auto IP setting can be executed even in this state, but IP addresses will be set only for the number of devices that can be registered.
- The unit may not be able to detect all of the remote cameras when, for example, multiple remote cameras are started at the same time.  
In this case, select [RETRY] in the [EXEC] item and press the F4 dial to retry.
- If the number of newly detected devices does not match the number of devices that are to actually be set, such as if the power of the remote camera was not on, etc., solve the problem, then select [RETRY] in the [EXEC] item and press the F4 dial to retry.

**Notes**

- When adding another remote camera controller (AW-RP60 [this unit]), set an IP address that is not a duplicate of any IP address within the same network before making the connection.
- Execute "auto IP setting" when devices not applicable for auto IP setting (devices other than the remote cameras) are in a non-operation state in the same network. After executing "auto IP setting", connect these devices after checking that there is no duplicate IP address within the same network.

### Manually setting the connection destination IP addresses (remote cameras) and port number

Use the following procedure when connecting (via a router) remote cameras whose IP addresses cannot be set by following the steps in "auto IP setting" or to manually configure the link settings for the unit and remote cameras.

1. Select the **[MANUAL IP SET/USER AUTH] SYSTEM** menu.
2. Turn the F1 dial to display the camera number whose settings you want to change and then press F1 dial to confirm.

C001 : AW-UE70			TALLY: <span style="color: red;">■</span> <span style="color: green;">■</span>
<b>MANUAL IP SET/USER AUTH</b>			<b>1/2</b>
CAM SEL			
<b>CAM1</b>			
CAM IP			
<b>192</b>	<b>168</b>	<b>0</b>	<b>10</b>
PORT			SAVE
<b>80</b>			<b>(push)</b>

3. **Set the IP address (remote camera) and PORT number.**  
 Operate [CAM SEL] in the first row to select the camera number for which you want to set the IP address that will be the connection destination.  
 The rows from the second and so on display the existing IP address and PORT number for each corresponding camera number.  
 Set the connection destination IP address in [CAM IP] in the second row.  
 The screen is divided into 4 blocks and these are set using the F1 to F4 dials.  
 Set the connection destination PORT number in [PORT] in the third row using the F1 dial.  
 Execute [SAVE] after setting. The set IP address and PORT number settings are not updated if [SAVE] is not executed.

Setting is also possible for camera numbers whose connection type is [NON] or [Serial] in [SYSTEM] > [CONNECT SETTING].

- This is set to the following value by default.

**CAM1** : 192.168.0.10  
 ↓  
**CAM200** : 192.168.0.209

- When the IP address of the connection destination is changed, checks are made for duplicate IP addresses set in other items. The "IP Duplicate!" message is displayed when the IP address is duplicated.
- The "Unavailable network setting" message is displayed when the PORT number specified cannot be set.

### ■ Settable port numbers

You can set a value within the range of 1 to 65535. However, the following values cannot be set even though they are within this range.

20, 21, 23, 25, 42, 53, 67, 68, 69, 110, 123, 161, 162, 995, 10669, 10670

#### Note

- The IP addresses set on the remote cameras are not changed by this operation.

### Set the user account of the camera to be connected

Set the account information of the camera to be connected.

1. Select the **[MANUAL IP SET/USER AUTH] SYSTEM** menu.
2. Operate the menu operation dials to select **[USER NAME]** and press to confirm.

C001 : AW-UE70		TALLY: <span style="color: red;">■</span> <span style="color: green;">■</span>
<b>MANUAL IP SET/USER AUTH</b>		<b>2/2</b>
USER NAME		
PASSWORD		
RETYPE PASSWORD	SAVE	
	<b>NO?</b>	

3. **Set the account which has already been set in the camera.**  
 To enter the account, select a single character by turning the F1 dial and press each time to set it.  
 Press the F2 dial to delete the character.
4. **Operate the menu operation dials to select the [SAVE] item.**
5. **Turn the F4 dial to select [Yes] and press the F4 dial to confirm.**  
 If [SAVE] is not executed, the changes are not reflected on the unit.

## Initializing the connection destination IP addresses set on the unit

Use the following procedure to initialize the connection types and connection destination IP addresses set on the unit.

1. Select the [RP INITIALIZE] MAINTENANCE menu.
2. Operate the menu operation dials to select [INIT ALL] and press to confirm.

C001 :AW-UE70		TALLY: <span style="color:red">■</span> <span style="color:green">■</span>	
RP INITIALIZE		1/1	
INIT ALL	INIT		
NO?	NO?		

3. Turn the F1 dial to execute initialization.

The settings for connecting with the remote cameras are initialized. When this operation is performed, all the settings on this unit are returned to the factory default conditions.

### Memo

- [CAM1] is initialized to [Serial].  
[CAM2] to [CAM200] are initialized to [NON].
- If the IP address of the unit is changed, the connection destination IP addresses are changed automatically.
  - IP addresses after the IP address of the unit are set for the camera numbers in ascending order.

# Menu

## Menu group

PAINT	SCENE	⇒ "SCENE" (page 38)
	SHUTTER	⇒ "SHUTTER" (page 39)
	CHROMA	⇒ "CHROMA" (page 39)
	GAIN	⇒ "GAIN" (page 40)
	WHITE BALANCE	⇒ "WHITE BALANCE" (page 40)
	GAMMA	⇒ "GAMMA" (page 41)
	DRS	⇒ "DRS" (page 41)
	DTL	⇒ "DTL" (page 42)
	COLOR CORRECT	⇒ "COLOR CORRECT" (page 42)
	DNR	⇒ "DNR" (page 44)
	PEDESTAL	⇒ "PEDESTAL" (page 45)
	CONTRAST	⇒ "CONTRAST" (page 45)
	FUNCTION	USER ASSIGN
CAMERA INFO		⇒ "CAMERA INFO" (page 48)
PTZ INFO1		⇒ "PTZ INFO1" (page 49)
PTZ INFO2		⇒ "PTZ INFO2" (page 50)
HOUSING		⇒ "HOUSING" (page 51)
CROP		⇒ "CROP" (page 52)
MAINTENANCE	RP SETTING	⇒ "RP SETTING" (page 53)
	RP INITIALIZE	⇒ "RP INITIALIZE" (page 54)
	RP VERSION	⇒ "RP VERSION" (page 55)
	GPI TALLY	⇒ "GPI TALLY" (page 56)
	GPIO CAM SEL	⇒ "GPIO CAM SEL" (page 57)
	GPO CAM.G	⇒ "GPO CAM.G" (page 59)
	GPI PMEM	⇒ "GPI PMEM" (page 60)
	GPI PMEM.G	⇒ "GPI PMEM.G" (page 61)
PMEM	PMEM LIST	⇒ "PMEM LIST" (page 64)
	SETTING	⇒ "SETTING" (page 65)
SYSTEM	CAMERA	⇒ "CAMERA" (page 67)
	CONNECT SETTING	⇒ "CONNECT SETTING" (page 68)
	MANUAL IP SET/USER AUTH	⇒ "MANUAL IP SET/USER AUTH" (page 69)
	AUTO IP SET	⇒ "AUTO IP SET" (page 70)
	RP IP SET	⇒ "RP IP SET" (page 71)
	TRACKING	⇒ "TRACKING" (page 72)

**PAINT**

⇒“SCENE” (page 38)
⇒“SHUTTER” (page 39)
⇒“CHROMA” (page 39)
⇒“GAIN” (page 40)
⇒“WHITE BALANCE” (page 40)
⇒“GAMMA” (page 41)
⇒“DRS” (page 41)
⇒“DTL” (page 42)
⇒“COLOR CORRECT” (page 42)
⇒“DNR” (page 44)
⇒“PEDESTAL” (page 45)
⇒“CONTRAST” (page 45)

**■ SCENE**

- The setting values and available setting items depend on the connected camera.

<b>C001 : AW-UE70</b>		<b>TALLY:</b> 	
<b>SCENE</b>		<b>1/1</b>	
<b>SCENE</b>			
<b>SCENE1</b>			

Item	Setting details
<b>SCENE</b>	Selected here is the shooting mode that matches the shooting situation.

■ SHUTTER

● The setting values and available setting items depend on the connected camera.

<b>C001 :AW-UE70</b>		<b>TALLY:</b> 	
<b>SHUTTER</b>		<b>1/1</b>	
<b>MODE</b>	<b>SPEED</b>		
<b>OFF</b>	<b>—</b>		

Item	Setting details
<b>MODE</b>	Select for camera shutter mode.
<b>SPEED</b>	Select the shutter speed for the camera.

■ CHROMA

● The setting values and available setting items depend on the connected camera.

<b>C001 :AW-UE70</b>		<b>TALLY:</b> 	
<b>CHROMA</b>		<b>1/1</b>	
<b>LEVEL</b>			
<b>+ 2</b>			

Item	Setting details
<b>LEVEL</b>	Set here the color intensity (chroma level) of the images.

■ **GAIN**

- The setting values and available setting items depend on the connected camera.

<b>C001 : AW-UE70</b>		<b>TALLY:</b> 	
<b>GAIN</b>		<b>1/1</b>	
<b>GAIN</b>	<b>AGC MAX</b>		
<b>AUTO</b>	<b>24dB</b>		

Item	Setting details
<b>GAIN</b>	The image gain is adjusted here. In locations which are too dark, adjust the gain upward; conversely, in locations which are too bright, adjust it downward.
<b>AGC MAX</b>	When [AUTO] is selected as the [GAIN] setting, the maximum gain-up amount can be set.

■ **WHITE BALANCE**

- The setting values and available setting items depend on the connected camera.

<b>C001 : AW-UE70</b>		<b>TALLY:</b> 	
<b>WHITE BALANCE</b>		<b>1/1</b>	
<b>MODE</b>	<b>COLOR TMP</b>	<b>R GAIN</b>	<b>B GAIN</b>
<b>ATW</b>	<b>—</b>	<b>—</b>	<b>—</b>

Item	Setting details
<b>MODE</b>	Set the white balance mode. Select the mode when the coloring is not natural because of the nature of the light source or other factors. If the white color serving as the reference can be recognized, subjects can be shot with natural coloring.
<b>COLOR TMP</b>	Specify a color temperature.
<b>R GAIN</b>	Adjust the gain of the R channel.
<b>B GAIN</b>	Adjust the gain of the B channel.



■ **GAMMA**

● The setting values and available setting items depend on the connected camera.

<b>C001 : AW-UE70</b>		<b>TALLY:</b> 	
<b>GAMMA</b>		<b>1/1</b>	
<b>TYPE</b>	<b>LEVEL</b>		
<b>NORMAL</b>	<b>MID</b>		

Item	Setting details
<b>TYPE</b>	Select the type of gamma curve.
<b>LEVEL</b>	Adjust the gamma correction level. Specifying smaller values results in a gentler gamma curve for the slope of low-brightness areas and sharper contrast. Specifying larger values results in an expanded gradient for dark areas and produces brighter images. The gamma curve for lowbrightness areas will be steeper, and contrast will be softer.

■ **DRS**

● The setting values and available setting items depend on the connected camera.

<b>C001 : AW-UE70</b>		<b>TALLY:</b> 	
<b>DRS</b>		<b>1/1</b>	
<b>DRS</b>			
<b>OFF</b>			

Item	Setting details
<b>DRS</b>	Set the DRS function which performs correction when video with high light/dark contrast is displayed.

■ DTL

● The setting values and available setting items depend on the connected camera.

<b>C001 : AW-UE70</b>			<b>TALLY:</b> 
<b>DTL</b>			<b>1/1</b>
<b>DTL</b>	<b>H LEVEL</b>	<b>L LEVEL</b>	<b>FLESH TONE</b>
<b>LOW</b>	<b>18</b>	<b>9</b>	<b>OFF</b>

Item	Setting details
<b>DTL</b>	Adjust the contour correction level (master).
<b>H LEVEL</b>	Adjusts the contour correction level when [DTL] is set to [HIGH].
<b>L LEVEL</b>	Adjusts the contour correction level when [DTL] is set to [LOW].
<b>FLESH TONE</b>	Sets flesh tone mode to make the skin of subjects appear smoother and more attractive.

■ COLOR CORRECT

● The setting values and available setting items depend on the connected camera.

<b>C001 : AW-UE70</b>			<b>TALLY:</b> 
<b>COLOR CORRECT</b>			<b>1/3</b>
<b>TYPE</b>			
<b>NTSC</b>			
<b>CORRECT</b>	<b>SAT</b>	<b>PHASE</b>	
<b>B</b>	<b>0</b>	<b>0</b>	
<b>SAT</b>	<b>PHASE</b>	<b>SAT</b>	<b>PHASE</b>
<b>B</b>	<b>B</b>	<b>B_B_Mg</b>	<b>B_B_Mg</b>
<b>0</b>	<b>0</b>	<b>0</b>	<b>0</b>

<b>C001 : AW-UE70</b>			<b>TALLY:</b> 
<b>COLOR CORRECT</b>			<b>2/3</b>
SAT B_Mg_Mg	PHASE B_Mg_Mg	SAT Mg	PHASE Mg
0	0	0	0
SAT Mg_R	PHASE Mg_R	SAT R	PHASE R
0	0	0	0
SAT R_R_YI	PHASE R_R_YI	SAT R_YI_YI	PHASE R_YI_YI
0	0	0	0

<b>C001 : AW-UE70</b>			<b>TALLY:</b> 
<b>COLOR CORRECT</b>			<b>3/3</b>
SAT YI	PHASE YI	SAT YI_YI_G	PHASE YI_YI_G
0	0	0	0
SAT YI_G_G	PHASE YI_G_G	SAT G	PHASE G
0	0	0	0
SAT G_Cy	PHASE G_Cy	SAT Cy_B_B	PHASE Cy_B_B
0	0	0	0

Item	Setting details
TYPE	Select the type of color matrix.
CORRECT	Adjust the saturation and hue.
SAT	Adjust the saturation for each color.
PHASE	Adjust the hue for each color.
SAT B	Adjust the saturation of blue.
PHASE B	Adjust the hue of blue.
SAT B_B_Mg	Adjusts the color saturation with a 3:1 blue to magenta ratio.
PHASE B_B_Mg	Adjusts the hue with a 3:1 blue to magenta ratio.
SAT B_Mg_Mg	Adjusts the color saturation with a 1:3 blue to magenta ratio.
PHASE B_Mg_Mg	Adjusts the hue with a 1:3 blue to magenta ratio.
SAT Mg	Adjust the saturation of magenta.
PHASE Mg	Adjust the hue of magenta.
SAT Mg_R	Adjust the saturation of the color between magenta and red.
PHASE Mg_R	Adjust the hue of the color between magenta and red.
SAT R	Adjust the saturation of red.
PHASE R	Adjust the hue of red.
SAT R_R_YI	Adjust the saturation of the color with a ratio of 3:1 red and yellow.
PHASE R_R_YI	Adjust the hue of the color with a ratio of 3:1 red and yellow.
SAT R_YI_YI	Adjust the saturation of the color with a ratio of 1:3 red and yellow.
PHASE R_YI_YI	Adjust the hue of the color with a ratio of 1:3 red and yellow.
SAT YI	Adjust the saturation of yellow.
PHASE YI	Adjust the hue of yellow.
SAT YI_YI_G	Adjust the saturation of the color with a ratio of 3:1 yellow and green.
PHASE YI_YI_G	Adjust the hue of the color with a ratio of 3:1 yellow and green.

**Menu (continued)**

Item	Setting details
SAT YI_G_G	Adjusts the color saturation with a 1:3 yellow to green ratio.
PHASE YI_G_G	Adjusts the hue with a 1:3 yellow to green ratio.
SAT G	Adjust the saturation of green.
PHASE G	Adjust the hue of green.
SAT G_Cy	Adjust the saturation of the color between green and cyan.
PHASE G_Cy	Adjust the hue of the color between green and cyan.
SAT Cy_B_B	Adjusts the color saturation with a 1:3 cyan to blue ratio.
PHASE Cy_B_B	Adjusts the hue with a 1:3 cyan to blue ratio.

■ **DNR**

- The setting values and available setting items depend on the connected camera.

<b>C001 : AW-UE70</b>		<b>TALLY:</b> 	
<b>DNR</b>		<b>1/1</b>	
<b>DNR</b>			
<b>LOW</b>			

Item	Setting details
DNR	Set the digital noise reduction level for outputting bright, clear images without noise, even at night and low-light conditions.

■ PEDESTAL

● The setting values and available setting items depend on the connected camera.

<b>C001 : AW-UE70</b>			<b>TALLY:</b> 
<b>PEDESTAL</b>			<b>1/1</b>
<b>M.PED</b>			
<b>0</b>			

Item	Setting details
M.PED	Use this to adjust the master pedestal.

■ CONTRAST

● The setting values and available setting items depend on the connected camera.

<b>C001 : AW-UE70</b>			<b>TALLY:</b> 
<b>CONTRAST</b>			<b>1/1</b>
<b>MODE</b>	<b>LEVEL</b>		
<b>AUTO</b>	<b>+ 3</b>		
<b>FRAME MIX</b>	<b>A.FRAME MIX MAX</b>	<b>DAY/NIGHT</b>	<b>NIGHT.D LEVEL</b>
<b>AUTO</b>	<b>0dB</b>	<b>DAY</b>	<b>MID</b>

Item	Setting details
<b>MODE</b>	Selects AUTO/MANUAL for image brightness (contrast) control.
<b>LEVEL</b>	Sets the convergence level for adjusting image brightness. This is enabled when [MODE] is [AUTO].
<b>FRAME MIX</b>	Selects for frame addition (gain-up using sensor storage) amount.
<b>A.FRAME MIX MAX</b>	Sets the maximum amount of frame addition for when [AUTO] is selected in [MODE] or [AUTO] is selected in [FRAME MIX].
<b>DAY/NIGHT</b>	Switches between standard shooting (day mode) and night-vision shooting (night mode: shooting with infrared light).
<b>NIGHT.D LEVEL</b>	Adjusts the level for switching from NIGHT mode to DAY mode when [DAY/NIGHT] is [AUTO].

**FUNCTION**

- ⇒ "USER ASSIGN" (page 46)
- ⇒ "CAMERA INFO" (page 48)
- ⇒ "PTZ INFO1" (page 49)
- ⇒ "PTZ INFO2" (page 50)
- ⇒ "HOUSING" (page 51)
- ⇒ "CROP" (page 52)

■ **USER ASSIGN**

<b>C001 :AW-UE70</b>			<b>TALLY:</b> 
<b>USER ASSIGN</b>			
<b>USER1</b>	<b>USER2</b>	<b>USER3</b>	<b>USER4</b>
<b>I.S.</b>	<b>ND1</b>	<b>ND2</b>	<b>ND3</b>
<b>USER5</b>	<b>USER6</b>	<b>USER7</b>	<b>USER8</b>
<b>ND4</b>	<b>D.EXT</b>	<b>D.ZOOM</b>	<b>FREEZE.D</b>

Menu (continued)

Item	Initial setting	Setting details
USER1	I.S.	<p>It is possible to allocate the following functions to the user buttons.</p> <p><b>POWER OFF:</b> Power off function</p> <p><b>ND1, ND2, ND3, ND4:</b> ND1 to ND4 functions</p> <p><b>FREEZE.D:</b> Freeze during function</p> <p><b>D.ZOOM:</b> Digital zoom function</p> <p><b>D.EXT:</b> D.EXT (OFF/×1.4) function</p> <p><b>D-EXT×2.0:</b> D.EXT (OFF/×2.0) function (This feature is available when connected to a camera for business applications that is equipped with the double digital extender function.)</p> <p><b>CROP SW:</b> Crop SW On/Off function (This feature is available when connected to a camera for business applications that is equipped with the CROP function.)</p> <p><b>C.OT YL, C.OT G, C.OT MG:</b> YL, G, MG selection in Crop Out (This feature is available when connected to a camera for business applications that is equipped with the CROP function.)</p> <p><b>C.AJ YL, C.AJ G, C.AJ MG:</b> YL, G, MG selection in Crop Adjust (This feature is available when connected to a camera for business applications that is equipped with the CROP function.)</p> <p><b>C.MK YL, C.MK G, C.MK MG:</b> YL, G, MG selection in Crop Marker (This feature is available when connected to a camera for business applications that is equipped with the CROP function.)</p> <p><b>WIPER:</b> Wiper selection (This feature is available when connected to a camera for business applications that is equipped with the WIPER function.)</p> <p><b>D. HAZE:</b> D.HAZE CLR SW On/Off function (This feature is available when connected to a camera for business applications that is equipped with the D.HAZE function.)</p> <p><b>DEFROSTER:</b> Defroster On/Off function (This feature is available when connected to a camera for business applications that is equipped with the DEFROSTER function.)</p> <p><b>HEATER:</b> Heater On/Off function (This feature is available when connected to a camera for business applications that is equipped with the HEATER function.)</p> <p><b>FAN:</b> Fan On/Off function</p> <p><b>WASHER:</b> Washer On/Off function (This feature is available when connected to a camera for business applications that is equipped with the WASHER function.)</p> <p><b>CAM LOCK:</b> CAM LOCK setting/cancel function (This feature is available when connected to a camera for business applications that is equipped with the CAM LOCK function.)</p> <p><b>TRACKING:</b> Tracking On/Off function</p> <p><b>TR CNCT:</b> TR CONNECT On/Off function</p> <p><b>SCENE1, SCENE2, SCENE3, SCENE4:</b> SCENE1 to SCENE4 allocation</p> <p><b>SHOOTING:</b> Shooting mode (NORMAL/H.SENSE) function (This feature is available when connected to a camera for business applications that is equipped with the SHOOTING function.)</p> <p><b>I.S.:</b> Camera I.S. function ON/OFF</p> <p><b>I.S.Ext:</b> Use this to enable the second setting level when there is a setting value for a second level on a camera for business applications, rather than an ON/OFF setting for the function. Refer to the operating instructions for the models that support this.</p>
USER2	ND1	
USER3	ND2	
USER4	ND3	
USER5	ND4	
USER6	D.EXT	
USER7	D.ZOOM	
USER8	FREEZE.D	

■ CAMERA INFO

● The setting values and available setting items depend on the connected camera.

C001 : AW-UE70			TALLY: 
CAMERA INFO			1/2
ND	OPT		
<b>ND1</b>	<b>OFF</b>		
D.ZOOM	D.ZOOM MAX	D.EXT	
<b>ON</b>	<b>x12</b>	<b>OFF</b>	
I.S.	BARS TYP		
<b>OFF</b>	<b>TYPE2</b>		

C001 : AW-UE70			TALLY: 
CAMERA INFO			2/2
OSD STAT	AUDIO	GENLOCK	
<b>OFF</b>	<b>OFF</b>	<b>—</b>	
HDR	BK LIGHT		
<b>OFF</b>	<b>OFF</b>		

Item	Setting details
ND	Set the ND filter.
OPT	Switch between standard shooting mode and night mode.
D.ZOOM	Enable (ON) or disable (OFF) the digital zoom function.
D.ZOOM MAX	Set the maximum digital zoom magnification.
D.EXT	Select the digital extender function.
I.S.	Select the image stabilization mode.
BARS TYP	Changes the type of color bar to display.
OSD STAT	Sets ON/OFF for status display during AWB execution.
AUDIO	Sets the audio input signal from the device connected to the audio input connector to ON/OFF.
GENLOCK	Adjusts the horizontal phase during genlock.
HDR	Adjusts the effect of the high dynamic range mode.
BK LIGHT	Sets the backlight correction function to ON/OFF.



■ PTZ INFO1

● The setting values and available setting items depend on the connected camera.

<b>C001 : AW-UE70</b>			<b>TALLY:</b> 
<b>PTZ INFO1</b>			<b>1/1</b>
<b>SPEED WTH Z</b>	<b>ZOOM MIN SPD</b>	<b>FREEZE</b>	
<b>OFF</b>	<b>OFF</b>	<b>OFF</b>	
<b>LIMIT UP</b>	<b>LIMIT DOWN</b>	<b>LIMIT LEFT</b>	<b>LIMIT RIGHT</b>
<b>OFF</b>	<b>OFF</b>	<b>OFF</b>	<b>OFF</b>
<b>P/T CURVE</b>	<b>FOCUS/ IRIS</b>		
<b>1</b>	<b>STNDRD</b>		

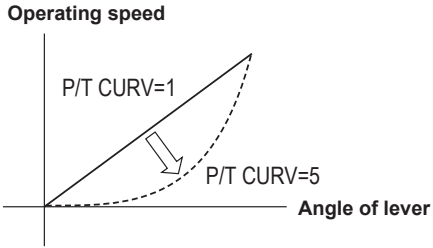
Item	Setting details
<b>SPEED WTH Z</b>	Enable (ON) or disable (OFF) the function used to adjust the pan-tilt adjustment speed in conjunction with the zoom magnification. When [ON] is set, the panning and tilting operations will become slower in the zoom status.
<b>ZOOM MIN SPD</b>	Calibrate the amount of zoom control sent from the unit so that lens zooming starts smoothly when the ZOOM button is pressed in slowly. Watch the images on the monitor to see if lens zooming starts smoothly when the ZOOM button is pressed in slowly. Calibration starts at [1], the least amount, to [8], the most. There is no calibration when [OFF] is selected.
<b>FREEZE</b>	Enable (ON) or disable (OFF) the function for freezing images during preset playback. When this is set to [ON], preset playback is performed with a still of the image immediately preceding the start of preset playback being output. The image freeze is released when preset playback is finished.
<b>LIMIT UP</b>	You can set the limiter of the remote camera in the direction of the upper limit from this unit.
<b>LIMIT DOWN</b>	You can set the limiter of the remote camera in the direction of the lower limit from this unit.
<b>LIMIT LEFT</b>	You can set the limiter of the remote camera in the direction of the left limit from this unit.
<b>LIMIT RIGHT</b>	You can set the limiter of the remote camera in the direction of the right limit from this unit.
<b>P/T CURVE</b>	You can adjust the relationship between the angle and operation speed when the PAN/TILT lever is tilted. <div style="text-align: right;">  </div>
<b>FOCUS/IRIS</b>	You can switch the operations of the FOCUS dial and the IRIS dial. <b>EXCHANGE:</b> Switches the operations of the FOCUS dial and the IRIS dial. The operations of the auto focus button and the auto iris button are also switched when [EXCHANGE] is selected. ● The one-touch auto focus button is disabled. ● Operation of the FOCUS SPEED dial is disabled. ● Speed is fixed to the setting it was at the time the setting is changed to [EXCHANGE]. <b>STANDARD:</b> Reverts the operations of the FOCUS dial and the IRIS dial.

■ PTZ INFO2

<b>C001 : AW-UE70</b>		<b>TALLY:</b> 	
<b>PTZ INFO2</b>		<b>1/1</b>	
<b>CAM SEL</b>			
<b>CAM1</b>			
<b>PAN DIR</b>	<b>TILT DIR</b>	<b>ZOOM DIR</b>	<b>FOCUS DIR</b>
<b>NORMAL</b>	<b>NORMAL</b>	<b>NORMAL</b>	<b>NORMAL</b>
<b>IRIS DIR</b>			
<b>NORMAL</b>			

Item	Setting details
<b>CAM SEL</b>	Settings can be made for rows from the second and so on for the selected camera number.
<b>PAN DIR</b>	Set the operating direction for the remote camera with the pan operation. <b>NORMAL:</b> When the PAN/TILT lever is tilted to the left, the remote camera moves to the left, and when tilted to the right it moves to the right. <b>REVERSE:</b> Reverses the direction of operation of NORMAL.
<b>TILT DIR</b>	Set the operating direction for the remote camera with the tilt operation. <b>NORMAL:</b> When the PAN/TILT lever is tilted away, the remote camera moves up, and when tilted towards the user it moves down. <b>REVERSE:</b> Reverses the direction of operation of NORMAL.
<b>ZOOM DIR</b>	Set the operating direction for the remote camera with the zoom operation. <b>NORMAL:</b> When the TELE side of the ZOOM button is pressed, the lens moves towards the telephoto end, and when WIDE is pressed it moves towards the wide-angle end. <b>REVERSE:</b> Reverses the direction of operation of NORMAL.
<b>FOCUS DIR</b>	Set the operating direction for the remote camera with the focus operation. <b>NORMAL:</b> When the FOCUS dial is turned to the right, the focus moves to the far end, and when turned to the left, it moves to the near end. <b>REVERSE:</b> Reverses the direction of operation of NORMAL.
<b>IRIS DIR</b>	Set the operating direction for the remote camera with the iris operation. <b>NORMAL:</b> When the IRIS dial is turned to the right it moves in the open direction, and when it is turned to the left it moves in the close direction. <b>REVERSE:</b> Reverses the direction of operation of NORMAL.

■ HOUSING

(For future expansion feature. This function is available when connecting a camera which is equipped with the HOUSING function.)

- The setting values and available setting items depend on the connected camera.

<b>C001 : AW-UE70</b>			<b>TALLY:</b> 
<b>HOUSING</b>			<b>1/1</b>
<b>FAN</b>	<b>HEATER</b>	<b>DEFROSTER</b>	<b>WIPER</b>
—	—	—	—
<b>WASHER</b>			
—			

Item	Setting details
<b>FAN</b>	Set the cooling fan operation.
<b>HEATER</b>	Set the heater operation. (This feature is available when connected to a camera for business applications that is equipped with the HEATER function.)
<b>DEFROSTER</b>	Set the defroster device operation. (This feature is available when connected to a camera for business applications that is equipped with the DEFROSTER function.)
<b>WIPER</b>	Set the wiper operation. (This feature is available when connected to a camera for business applications that is equipped with the WIPER function.)
<b>WASHER</b>	Clean the lens by spraying washer fluid on to it. (This feature is available when connected to a camera for business applications that is equipped with the WASHER function.) If you select [ON], the camera head moves to the position of the washer nozzle, washer fluid is sprayed for a specific duration, and the camera head returns to the original position. The wiper also operates momentarily during cleaning.

■ CROP

(For future expansion feature. This function is available when connecting a camera which is equipped with the CROP function.)

- The setting values and available setting items depend on the connected camera.

<b>C001 : AW-UE70</b>			<b>TALLY:</b> 
<b>CROP</b>			<b>1/1</b>
<b>SW</b>	<b>ADJUST</b>	<b>H POS</b>	<b>V POS</b>
—	—	—	—
<b>OUT</b>	<b>MARKER</b>		
—	—		

Item	Setting details
<b>SW</b>	Enable (ON) or disable (OFF) the CROP function which crops UHD (3840×2160) images to FHD (1920×1080) images.
<b>ADJUST</b>	Make selections for the crop frame to adjust positioning.
<b>H POS</b>	Make settings for the position in the horizontal direction for the crop frame specified in [ADJUST]. 0 is the left edge and 1920 is the right edge.
<b>V POS</b>	Make settings for the position in the vertical direction for the crop frame specified in [ADJUST]. 0 is the upper edge and 1080 is the lower edge.
<b>OUT</b>	Make the settings for the crop frame for images output to the 3G SDI OUT terminal and IP.
<b>MARKER</b>	Make the settings for the crop frame displayed for images output to the MONI OUT terminal.

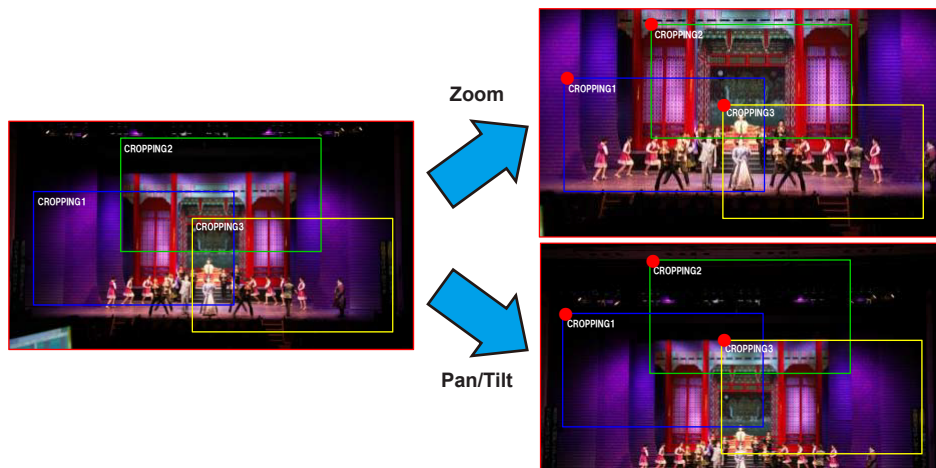

**MAINTENANCE**

⇒ "RP SETTING" (page 53)
⇒ "RP INITIALIZE" (page 54)
⇒ "RP VERSION" (page 55)
⇒ "GPI TALLY" (page 56)
⇒ "GPIO CAM SEL" (page 57)
⇒ "GPO CAM.G" (page 59)
⇒ "GPI PMEM" (page 60)
⇒ "GPI PMEM.G" (page 61)

■ RP SETTING

<b>C001 : AW-UE70</b>		<b>TALLY:</b>	
<b>RP SETTING</b>		<b>1/2</b>	
<b>LCD BRIGHT</b>	<b>LED BRIGHT</b>		<b>BUZZER</b>
<b>10</b>	<b>3</b>		<b>ON</b>
<b>GPIO MODE</b>	<b>MENU BT MODE</b>		
<b>MODE1</b>	<b>PMEM OFF</b>		
<b>PC_TOOL LINK</b>			
<b>DISABLE</b>			

<b>C001 : AW-UE70</b>		<b>TALLY:</b>	
<b>RP SETTING</b>		<b>2/2</b>	
<b>NEW ID</b>	<b>OLD ID</b>		
<b>NEW PASSWORD</b>	<b>OLD PASSWORD</b>		
<b>Retype PASSWORD</b>		<b>SAVE</b>	
		<b>No?</b>	

\_\_\_ indicates factory default settings.

Item	Setting value	Setting details
<b>LCD BRIGHT</b>	1 ⋮ <u>10</u>	Sets the brightness of the LCD panel.
<b>LED BRIGHT</b>	1 ⋮ <b>3</b> ⋮ 10	Set the brightness of the panel buttons.
<b>BUZZER</b>	OFF <u>ON</u>	Enable (ON) or disable (OFF) the buzzer (beep).
<b>GPIO MODE</b>	MODE1 MODE2	You can select control of the port of the TALLY/GPIO connector. For details, refer to "Control interface for external devices" (page 86).

Menu (continued)

Item	Setting value	Setting details
<b>MENU BT MODE</b>	PMEM OFF PMEM ON	You can enable or disable the PMEM button when the MENU button on the LCD panel is set to ON. <b>PMEM OFF:</b> This disables the PMEM function when MENU is set to ON and is used for the button to select the menu in the first layer. <b>PMEM ON:</b> This enables the PMEM function when MENU is set to ON and cannot be used for the button to select menu in the first layer.
<b>PC_TOOL LINK</b>	DISABLE ENABLE	Select [ENABLE] when using Setup Software. ● If you change the item using the F5 dial, this setting will return to [DISABLE]. Do not turn the F5 dial after [ENABLE] is set.
<b>NEW ID</b>		Use this to create a new ID. The ID can be 8-16 alphanumeric characters long. If the ID is not registered, the item name is displayed in red. Turn the F1 dial to select a single character. Press the F1 dial to set each character and enter the following values. Use the F2 dial to delete a single character. This unit is initialized when [INIT ALL] is executed in the RP INITIALIZE menu and will return to an unregistered state.
<b>OLD ID</b>		Displays the ID before the change. Turn the F3 dial to select a single character. Press the F3 dial to set each character and enter the following values. Use the F4 dial to delete a single character.
<b>NEW PASSWORD</b>		Use this to set a new password. The password can be 8-16 alphanumeric characters long. You can use the following characters and symbols. (Use a combination of the three types, alphabetical characters, numerical characters, and symbols, to set the password. You cannot set the same ID character string.) ● A to Z, a to z, 0 to 9 ● ~!@#\$\$%^&*()_+ \{}[]<>./?' If the password is not registered, the item name is displayed in red. Turn the F1 dial to select a single character. Press the F1 dial to set each character and enter the following values. Use the F2 dial to delete a single character. This unit is initialized when [INIT ALL] is executed in the RP INITIALIZE menu and will return to an unregistered state.
<b>OLD PASSWORD</b>		Displays the password before the change. Turn the F3 dial to select a single character. Press the F3 dial to set each character and enter the following values. Use the F4 dial to delete a single character.
<b>Retype PASSWORD</b>		Enter the password again. Turn the F1 dial to select a single character. Press the F1 dial to set each character and enter the following values. Use the F2 dial to delete a single character.
<b>SAVE</b>	No? Yes	Turn the F4 dial to select [Yes] and press the F4 dial. When pressing the F4 dial, the ID and password you have entered will be saved. ● Settings are not updated until [SAVE] is executed after the settings are changed.

■ RP INITIALIZE

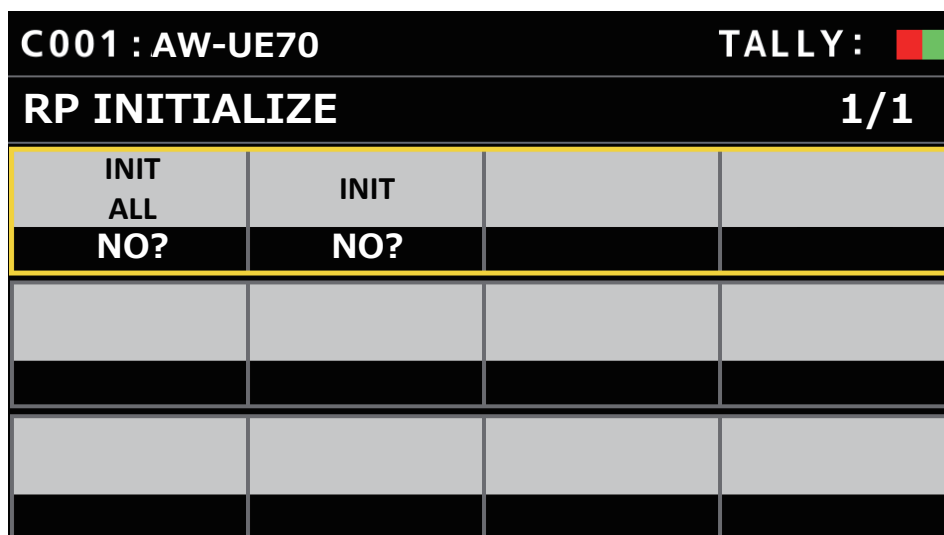

\_\_\_ indicates factory default settings.

Item	Setting value	Setting details
<b>INIT ALL</b>	NO? YES?	Return all settings managed by this unit, including network settings, to the factory default conditions.
<b>INIT</b>	NO? YES?	Return all settings managed by this unit, excluding network settings, to the factory default conditions. ● The account information for this unit is not initialized.

■ RP VERSION

<b>C001 :AW-UE70</b>		<b>TALLY:</b> 	
<b>RP VERSION</b>		<b>1/1</b>	
<b>SYSTEM VERSION</b>			
<b>1.00-00-0.00</b>			
<b>SOFT VERSION</b>	<b>FPGA VERSION</b>		
<b>1.00-00-0.00</b>	<b>1.00-00-0.00</b>		

Item	Setting value	Setting details
SYSTEM VERSION	–	Displays the system version for the unit.
SOFT VERSION	–	Displays the software version.
FPGA VERSION	–	Displays the FPGA version.

■ GPI TALLY

C001 : AW-UE70		TALLY: 	
GPI TALLY		1/1	
TALLY OUT			
OFF			
TALLY1	TALLY2	TALLY3	TALLY4
CAM1	CAM2	CAM3	CAM4
TALLY5			
CAM5			

\_\_\_ indicates factory default settings.

Item	Setting value	Setting details
TALLY OUT	OFF <u>ON</u>	Set whether to send a TALLY notification to the camera if TALLY is input through the port of the TALLY/GPIO connector. When connecting multiple remote camera controllers to control cameras, set this to [OFF] when the TALLY ON/OFF operation is not to be performed. When the TALLY ON/OFF operation is to be performed, make sure there is no duplication of camera allocations. <b>ON:</b> Notify <b>OFF:</b> Do not notify
TALLY1	<u>CAM1</u> ⋮ CAM200	Select the camera to send the TALLY notification to when there is an R_TALLY_1 or G_TALLY_1 input through the port of the TALLY/GPIO connector.
TALLY2	<u>CAM1</u> <u>CAM2</u> ⋮ CAM200	Select the camera to send the TALLY notification to when there is an R_TALLY_2 or G_TALLY_2 input through the port of the TALLY/GPIO connector.
TALLY3	<u>CAM1</u> ⋮ <u>CAM3</u> ⋮ CAM200	Select the camera to send the TALLY notification to when there is an R_TALLY_3 or G_TALLY_3 input through the port of the TALLY/GPIO connector.
TALLY4	<u>CAM1</u> ⋮ <u>CAM4</u> ⋮ CAM200	Select the camera to send the TALLY notification to when there is an R_TALLY_4 or G_TALLY_4 input through the port of the TALLY/GPIO connector.
TALLY5	<u>CAM1</u> ⋮ <u>CAM5</u> ⋮ CAM200	Select the camera to send the TALLY notification to when there is an R_TALLY_5 or G_TALLY_5 input through the port of the TALLY/GPIO connector.

**Note**

- The TALLY notification is sent if there are applicable cameras in the currently selected camera group. Cameras are not notified even if there is TALLY input for CAMERA groups that are not currently selected.



■ GPIO CAM SEL

<b>C001 : AW-UE70</b>				<b>TALLY :</b>
<b>GPIO CAM SEL</b>				<b>1/2</b>
<b>IN1</b>	<b>IN2</b>	<b>IN3</b>	<b>IN4</b>	
<b>CAM1</b>	<b>CAM2</b>	<b>CAM3</b>	<b>CAM4</b>	
<b>IN5</b>				
<b>CAM5</b>				
<b>OUT1</b>	<b>OUT2</b>	<b>OUT3</b>	<b>OUT4</b>	
<b>CAM1</b>	<b>CAM2</b>	<b>CAM3</b>	<b>CAM4</b>	

<b>C001 : AW-UE70</b>				<b>TALLY :</b>
<b>GPIO CAM SEL</b>				<b>2/2</b>
<b>OUT5</b>				
<b>CAM5</b>				

\_\_\_ indicates factory default settings.

Item	Setting value	Setting details
<b>IN1</b>	<u>CAM1</u> ⋮ CAM200	Select the camera to be switched when there is CAMERA_SELECT_IN1 input through the port of the TALLY/GPIO connector.
<b>IN2</b>	CAM1 <u>CAM2</u> ⋮ CAM200	Select the camera to be switched when there is CAMERA_SELECT_IN2 input through the port of the TALLY/GPIO connector.
<b>IN3</b>	CAM1 ⋮ <u>CAM3</u> ⋮ CAM200	Select the camera to be switched when there is CAMERA_SELECT_IN3 input through the port of the TALLY/GPIO connector.
<b>IN4</b>	CAM1 ⋮ <u>CAM4</u> ⋮ CAM200	Select the camera to be switched when there is CAMERA_SELECT_IN4 input through the port of the TALLY/GPIO connector.
<b>IN5</b>	CAM1 ⋮ <u>CAM5</u> ⋮ CAM200	Select the camera to be switched when there is CAMERA_SELECT_IN5 input through the port of the TALLY/GPIO connector.
<b>OUT1</b>	<u>CAM1</u> ⋮ CAM200	Notification is sent to CAMERA_SELECT_OUT1 of the port of the TALLY/GPIO connector when the set camera is selected.

## Menu (continued)

Item	Setting value	Setting details
<b>OUT2</b>	CAM1 CAM2 ⋮ CAM200	Notification is sent to CAMERA_SELECT_OUT2 of the port of the TALLY/GPIO connector when the set camera is selected.
<b>OUT3</b>	CAM1 ⋮ CAM3 ⋮ CAM200	Notification is sent to CAMERA_SELECT_OUT3 of the port of the TALLY/GPIO connector when the set camera is selected.
<b>OUT4</b>	CAM1 ⋮ CAM4 ⋮ CAM200	Notification is sent to CAMERA_SELECT_OUT4 of the port of the TALLY/GPIO connector when the set camera is selected.
<b>OUT5</b>	CAM1 ⋮ CAM5 ⋮ CAM200	Notification is sent to CAMERA_SELECT_OUT5 of the port of the TALLY/GPIO connector when the set camera is selected.

### Notes

- With regard to the operations of CAMERA\_SELECT\_IN of the port of the TALLY/GPIO connector, if a CAMERA number outside of the currently selected CAMERA group is specified, there is a switch in the CAMERA group. Selection of the camera may take some time in this case.
- Operations in regard to the CAMERA\_SELECT\_OUT of the port of the TALLY/GPIO connector will be operations on the applicable camera number in the currently selected camera group.

■ GPO CAM.G

<b>C001 :AW-UE70</b>			<b>TALLY:</b> 
<b>GPO CAM.G</b>			<b>1/1</b>
<b>OUT1</b>	<b>OUT2</b>	<b>OUT3</b>	<b>OUT4</b>
<b>GROUP1</b>	<b>GROUP2</b>	<b>GROUP3</b>	<b>GROUP4</b>
<b>OUT5</b>	<b>OUT6</b>	<b>OUT7</b>	<b>OUT8</b>
<b>GROUP5</b>	<b>GROUP6</b>	<b>GROUP7</b>	<b>GROUP8</b>

\_\_\_ indicates factory default settings.

Item	Setting value	Setting details
<b>OUT1</b>	<u>GROUP1</u> ⋮ GROUP40	Displays the camera group set for the CAM_GRP_SEL OUT1 terminal of the port for the TALLY/GPIO connector.
<b>OUT2</b>	GROUP1 <u>GROUP2</u> ⋮ GROUP40	Displays the camera group set for the CAM_GRP_SEL OUT2 terminal of the port for the TALLY/GPIO connector.
<b>OUT3</b>	GROUP1 ⋮ <u>GROUP3</u> ⋮ GROUP40	Displays the camera group set for the CAM_GRP_SEL OUT3 terminal of the port for the TALLY/GPIO connector.
<b>OUT4</b>	GROUP1 ⋮ <u>GROUP4</u> ⋮ GROUP40	Displays the camera group set for the CAM_GRP_SEL OUT4 terminal of the port for the TALLY/GPIO connector.
<b>OUT5</b>	GROUP1 ⋮ <u>GROUP5</u> ⋮ GROUP40	Displays the camera group set for the CAM_GRP_SEL OUT5 terminal of the port for the TALLY/GPIO connector.
<b>OUT6</b>	GROUP1 ⋮ <u>GROUP6</u> ⋮ GROUP40	Displays the camera group set for the CAM_GRP_SEL OUT6 terminal of the port for the TALLY/GPIO connector.
<b>OUT7</b>	GROUP1 ⋮ <u>GROUP7</u> ⋮ GROUP40	Displays the camera group set for the CAM_GRP_SEL OUT7 terminal of the port for the TALLY/GPIO connector.
<b>OUT8</b>	GROUP1 ⋮ <u>GROUP8</u> ⋮ GROUP40	Displays the camera group set for the CAM_GRP_SEL OUT8 terminal of the port for the TALLY/GPIO connector.

■ GPI PMEM

<b>C001 AW-UE70</b>			<b>TALLY:</b> 
<b>GPI PMEM</b>			<b>1/1</b>
<b>IN1</b>	<b>IN2</b>	<b>IN3</b>	<b>IN4</b>
<b>PMEM1</b>	<b>PMEM2</b>	<b>PMEM3</b>	<b>PMEM4</b>
<b>IN5</b>	<b>IN6</b>	<b>IN7</b>	<b>IN8</b>
<b>PMEM5</b>	<b>PMEM6</b>	<b>PMEM7</b>	<b>PMEM8</b>
<b>IN9</b>	<b>IN10</b>		
<b>PMEM9</b>	<b>PMEM10</b>		

\_\_\_ indicates factory default settings.

Item	Setting value	Setting details
<b>IN1</b>	PMEM1 ⋮ PMEM100	With the TALLY/GPIO connector, playback of the set preset number is performed when there is input through PRESET_SELECT_IN1.
<b>IN2</b>	PMEM1 PMEM2 ⋮ PMEM100	With the TALLY/GPIO connector, playback of the set preset number is performed when there is input through PRESET_SELECT_IN2.
<b>IN3</b>	PMEM1 ⋮ PMEM3 ⋮ PMEM100	With the TALLY/GPIO connector, playback of the set preset number is performed when there is input through PRESET_SELECT_IN3.
<b>IN4</b>	PMEM1 ⋮ PMEM4 ⋮ PMEM100	With the TALLY/GPIO connector, playback of the set preset number is performed when there is input through PRESET_SELECT_IN4.
<b>IN5</b>	PMEM1 ⋮ PMEM5 ⋮ PMEM100	With the TALLY/GPIO connector, playback of the set preset number is performed when there is input through PRESET_SELECT_IN5.
<b>IN6</b>	PMEM1 ⋮ PMEM6 ⋮ PMEM100	With the TALLY/GPIO connector, playback of the set preset number is performed when there is input through PRESET_SELECT_IN6.
<b>IN7</b>	PMEM1 ⋮ PMEM7 ⋮ PMEM100	With the TALLY/GPIO connector, playback of the set preset number is performed when there is input through PRESET_SELECT_IN7.
<b>IN8</b>	PMEM1 ⋮ PMEM8 ⋮ PMEM100	With the TALLY/GPIO connector, playback of the set preset number is performed when there is input through PRESET_SELECT_IN8.
<b>IN9</b>	PMEM1 ⋮ PMEM9 ⋮ PMEM100	With the TALLY/GPIO connector, playback of the set preset number is performed when there is input through PRESET_SELECT_IN9.
<b>IN10</b>	PMEM1 ⋮ PMEM10 ⋮ PMEM100	With the TALLY/GPIO connector, playback of the set preset number is performed when there is input through PRESET_SELECT_IN10.

■ GPI PMEM.G

<b>C001 : AW-UE70</b>		<b>TALLY :</b> 	
<b>GPI PMEM.G</b>		<b>1/2</b>	
<b>GPI IN SEL</b>	<b>PMEM MODE</b>		
<b>IN1</b>	<b>SEPARATE</b>		
<b>SEL1 CAM</b>	<b>SEL1 PM</b>	<b>SEL2 CAM</b>	<b>SEL2 PM</b>
<b>CAM1</b>	<b>PMEM1</b>	<b>CAM2</b>	<b>PMEM1</b>
<b>SEL3 CAM</b>	<b>SEL3 PM</b>	<b>SEL4 CAM</b>	<b>SEL4 PM</b>
<b>CAM3</b>	<b>PMEM1</b>	<b>CAM4</b>	<b>PMEM1</b>

<b>C001 : AW-UE70</b>		<b>TALLY :</b> 	
<b>GPI PMEM.G</b>		<b>2/2</b>	
<b>SEL5 CAM</b>	<b>SEL5 PM</b>	<b>SEL6 CAM</b>	<b>SEL6 PM</b>
<b>CAM5</b>	<b>PMEM1</b>	<b>CAM6</b>	<b>PMEM1</b>
<b>SEL7 CAM</b>	<b>SEL7 PM</b>	<b>SEL8 CAM</b>	<b>SEL8 PM</b>
<b>CAM7</b>	<b>PMEM1</b>	<b>CAM8</b>	<b>PMEM1</b>
<b>SEL9 CAM</b>	<b>SEL9 PM</b>	<b>SEL10 CAM</b>	<b>SEL10 PM</b>
<b>CAM9</b>	<b>PMEM1</b>	<b>CAM10</b>	<b>PMEM1</b>

\_\_\_ indicates factory default settings.

Item	Setting value	Setting details
<b>GPI IN SEL</b>	<u>IN1</u> ⋮ IN4	For each of the PRESET_MEM_GROUP_IN1 to 4 inputs on the TALLY/GPIO connector, it is possible to specify preset playback of a maximum of 10 cameras.
<b>PMEM MODE</b>	OFF SEPARATE ALL	Set the operation mode for each of the PRESET_MEM_GROUP_IN1 to 4 on the TALLY/GPIO connector. <b>OFF:</b> Preset playback is not performed even if there is input to PRESET_MEM_GROUP_IN1 to 4. <b>SEPARATE:</b> If there is input to PRESET_MEM_GROUP_IN1 to 4, preset playback instructions are performed according to the subsequent settings SEL1 to SEL10. <b>ALL:</b> Specify playback of the preset number set in SEL1 PM for all connected cameras when there is input through PRESET_MEM_GROUP_IN1.
<b>SEL1 CAM</b>	<u>CAM1</u> ⋮ CAM200	Select the camera number to playback.
<b>SEL1 PM</b>	<u>PMEM1</u> ⋮ PMEM100	Allocate the preset playback number to the camera selected with SEL1 CAM. However, when the [PMEM MODE] is [ALL], the preset number for specifying playback of all connected cameras is set.
<b>SEL2 CAM</b>	<u>CAM1</u> <u>CAM2</u> ⋮ CAM200	Select the camera number to playback.
<b>SEL2 PM</b>	<u>PMEM1</u> ⋮ PMEM100	Allocate the preset playback number to the camera selected with SEL2 CAM.

**Menu (continued)**

Item	Setting value	Setting details
<b>SEL3 CAM</b>	CAM1 ⋮ CAM3 ⋮ CAM200	Select the camera number to playback.
<b>SEL3 PM</b>	PMEM1 ⋮ PMEM100	Allocate the preset playback number to the camera selected with SEL3 CAM.
<b>SEL4 CAM</b>	CAM1 ⋮ CAM4 ⋮ CAM200	Select the camera number to playback.
<b>SEL4 PM</b>	PMEM1 ⋮ PMEM100	Allocate the preset playback number to the camera selected with SEL4 CAM.
<b>SEL5 CAM</b>	CAM1 ⋮ CAM5 ⋮ CAM200	Select the camera number to playback.
<b>SEL5 PM</b>	PMEM1 ⋮ PMEM100	Allocate the preset playback number to the camera selected with SEL5 CAM.
<b>SEL6 CAM</b>	CAM1 ⋮ CAM6 ⋮ CAM200	Select the camera number to playback.
<b>SEL6 PM</b>	PMEM1 ⋮ PMEM100	Allocate the preset playback number to the camera selected with SEL6 CAM.
<b>SEL7 CAM</b>	CAM1 ⋮ CAM7 ⋮ CAM200	Select the camera number to playback.
<b>SEL7 PM</b>	PMEM1 ⋮ PMEM100	Allocate the preset playback number to the camera selected with SEL7 CAM.
<b>SEL8 CAM</b>	CAM1 ⋮ CAM8 ⋮ CAM200	Select the camera number to playback.
<b>SEL8 PM</b>	PMEM1 ⋮ PMEM100	Allocate the preset playback number to the camera selected with SEL8 CAM.
<b>SEL9 CAM</b>	CAM1 ⋮ CAM9 ⋮ CAM200	Select the camera number to playback.
<b>SEL9 PM</b>	PMEM1 ⋮ PMEM100	Allocate the preset playback number to the camera selected with SEL9 CAM.
<b>SEL10 CAM</b>	CAM1 ⋮ CAM10 ⋮ CAM200	Select the camera number to playback.
<b>SEL10 PM</b>	PMEM1 ⋮ PMEM100	Allocate the preset playback number to the camera selected with SEL10 CAM.

## PMEM

### ■ Operating preset memory (PMEM)

The preset memory of a remote camera can be operated from the unit.

The following settings that you have adjusted in advance can be stored in preset memory.

- Pan/tilt positions
- Zoom positions
- Focus positions
- Lens iris settings (manual iris only)
- White balance settings
- Gain

#### Notes

- The preset memory is registered in the connection destination remote camera.
- The number of preset memory that can be registered differs depending on the remote camera.  
For details, check the Operating Instructions for the corresponding model.

⇒ "PMEM LIST" (page 64)

⇒ "SETTING" (page 65)

■ PMEM LIST

- You can view the preset memory registration status for the selected remote camera and play back preset memories by selecting preset numbers.

<b>C001 : AW-UE70</b>			<b>TALLY :</b>
<b>PMEM LIST</b>			<b>1/9</b>
1	2	3	4
<b>PMEM1</b>	<b>PMEM2</b>	<b>PMEM3</b>	<b>PMEM4</b>
5	6	7	8
<b>PMEM5</b>	<b>PMEM6</b>	<b>PMEM7</b>	<b>PMEM8</b>
9	10	11	12
<b>PMEM9</b>	<b>PMEM10</b>	<b>PMEM11</b>	<b>PMEM12</b>



<b>C001 AW-UE70</b>			<b>TALLY :</b>
<b>PMEM LIST</b>			<b>9/9</b>
97	98	99	100
<b>PMEM97</b>	<b>PMEM98</b>	<b>PMEM99</b>	<b>PMEM100</b>

Item	Setting value	Setting details
1 ⋮ 100 (These are preset numbers.)	PMEM1 ⋮ PMEM100 ● The displayed names can be changed with the Setup Software.	The preset memory registration status for the selected remote camera is displayed. The green display indicates that it is currently registered. Preset memory numbers in yellow indicate currently selected preset memories. <b>RECALL</b> In the selected row, when pressing any of the F1 to F4 dials located at the same position with the preset number column, you can recall preset. <b>STORE</b> <b>STORE button:</b> When the button is lit and press any of the F1 to F4 dials located at the same position with the preset number column, you can register the preset. <b>DELETE</b> <b>DELETE button:</b> When the button is lit and press any of the F1 to F4 dials located at the same position with the preset number column, you can delete the preset.



■ **SETTING**

- Make basic settings for preset memory.  
The setting values and available setting items depend on the connected camera.

<b>C001 : AW-UE70</b>			<b>TALLY:</b> 
<b>SETTING</b>			<b>1/2</b>
<b>SCOPE</b>	<b>RP CTRL SPD MODE</b>		<b>HOME</b>
<b>A</b>	<b>CAMERA</b>		<b>NO?</b>
<b>SPEED UNIT</b>	<b>SPEED TBL</b>	<b>SPEED</b>	
<b>STEP</b>	<b>SLOW</b>	<b>1</b>	
<b>D-EXT</b>	<b>ZOOM MODE</b>	<b>CROP</b>	
<b>OFF</b>	<b>A</b>	<b>OFF</b>	

<b>C001 : AW-UE70</b>			<b>TALLY:</b> 
<b>SETTING</b>			<b>2/2</b>
<b>PMEM GP CAL</b>			
<b>GROUP1</b>			

\_\_\_ indicates factory default settings.

Item	Setting value	Setting details
<b>SCOPE</b>	A B C	Specify the playback targets for items registered in the preset memory. <b>A:</b> Pan, Tilt, Zoom (including digital zoom), Focus, Iris, Gain, white balance adjustment value <b>B:</b> Pan, Tilt, Zoom (including digital zoom), Focus, Iris <b>C:</b> Pan, Tilt, Zoom (including digital zoom), Focus
<b>RP CTRL SPD MODE</b>	<u>CAMERA</u> RP	Determine the playback mode of the preset speed for playing back the preset memory. <b>CAMERA:</b> Playing back at the preset speed set in the remote camera. <b>RP:</b> Playing back at the preset speed registered when the preset memory was registered.
<b>HOME</b>	YES <u>NO?</u>	Return the pan-tilt head to home position.
<b>SPEED UNIT</b>	STEP TIME	The mode of the speed for playing back the preset memory is displayed. ● The setting is only enabled on remote cameras that have the SPEED UNIT function. ● This is only enabled with remote cameras where it is possible to specify times with PRESET SPEED. <b>STEP:</b> Playback moves to the preset position at the specified speed. <b>TIME:</b> Playback moves to the preset position in the specified time.
<b>SPEED TBL</b>	SLOW FAST	Set the mode of the speed when playing back preset memory.

## Menu (continued)

Item	Setting value	Setting details
<b>SPEED</b>	(Setting on the remote camera)	The movement speed or time up to the preset position is displayed. When the [SPEED UNIT] is [STEP], this displays the speed of movement to the preset position. When it is [TIME], this displays the time it will take to move to the preset position.
<b>D-EXT</b>	OFF ON	Set whether to set the digital extender On/Off when registering preset memories.
<b>ZOOM MODE</b>	A B	Select the zoom operation for when preset memory is recalled. <b>A:</b> Perform the zoom operation in line with the pan/tilt operation. <b>B:</b> Perform the zoom operation quicker than the pan/tilt operation.
<b>CROP</b>	OFF ON	When the preset memory is played back, set whether the reproduction of content set in the various [CROP] menus is OFF/ON. ● The setting is only enabled on remote cameras that are equipped with the CROP function.
<b>PMEM GP CAL</b>	<u>GROUP1</u> ⋮ GROUP4	Execute the setting content for [GPI IN SEL] set with the [MAINTENANCE] > [GPI PMEM.G] menu. Select the target group and press the F1 dial to execute. <b>GROUP1:</b> IN1 for GPI IN SEL <b>GROUP2:</b> IN2 for GPI IN SEL <b>GROUP3:</b> IN3 for GPI IN SEL <b>GROUP4:</b> IN4 for GPI IN SEL

**SYSTEM**

⇒ "CAMERA" (page 67)
⇒ "CONNECT SETTING" (page 68)
⇒ "MANUAL IP SET/USER AUTH" (page 69)
⇒ "AUTO IP SET" (page 70)
⇒ "RP IP SET" (page 71)
⇒ "TRACKING" (page 72)

■ CAMERA

<b>C001 : AW-UE70</b>			<b>TALLY:</b> 
<b>CAMERA</b>			
<b>CAM POWER</b>	<b>AUTO POWER</b>	<b>CAM LOCK</b>	
<b>NON</b>	<b>ON</b>	<b>—</b>	

\_\_\_ indicates factory default settings.

Item	Setting value	Setting details
<b>CAM POWER</b>	NON GRP OFF GRP ON ALL OFF ALL ON	Execute power On/Off instructions in regard to connected remote cameras. <b>NON:</b> Power On/Off instructions not executed. <b>GRP OFF:</b> Execute power Off (standby) instructions in regard to remote cameras belonging to the currently selected camera group. <b>GRP ON:</b> Execute power On instructions in regard to remote cameras belonging to the currently selected camera group. <b>ALL OFF:</b> Execute power Off (standby) instructions in regard to remote cameras set in this unit. <b>ALL ON:</b> Execute power On instructions in regard to remote cameras set in this unit. ● Depending on the number of remote cameras connected, the unit may take some time before it can be operated.
<b>AUTO POWER</b>	OFF <u>ON</u>	The power of remote cameras set in the unit turns on when the power of this unit is turned on. ● Depending on the number of remote cameras connected, the unit may take some time before it can be operated.
<b>CAM LOCK</b>	<u>UNLOCK</u> LOCK ● "—" is displayed for cameras without the feature.	<b>This feature is available when connected to a camera that is equipped with the CAM LOCK function.</b> When [LOCK] is selected, this unit and currently selected remote cameras cannot be controlled from another AW-RP60. While LOCK is on, currently selected remote cameras can only be controlled from the AW-RP60 on which LOCK was executed. Note that if you switch to another remote camera while LOCK is on, the LOCK is maintained on the remote cameras prior to camera selection, but the remote cameras after camera selection do not have LOCK applied. A key mark is displayed next to the camera name at the TOP of the LCD panel while LOCK is on. When [UNLOCK] is selected, the LOCK is released and the key mark disappears. <b>Green key mark:</b> This means that LOCK has been executed on this unit. <b>Red key mark:</b> This means that another AW-RP60 has been used for LOCK. Operation is not possible in this case.

■ CONNECT SETTING

<b>C001 : AW-UE70</b>		<b>TALLY:</b> 	
<b>CONNECT SETTING</b>		<b>1/17</b>	
<b>CAM SEL</b>	<b>CONNECT MODE</b>		
<b>CAM1</b>	<b>Serial</b>		
<b>CAM1</b>	<b>CAM2</b>	<b>CAM3</b>	<b>CAM4</b>
<b>Serial</b>	<b>NON</b>	<b>NON</b>	<b>NON</b>
<b>CAM5</b>	<b>CAM6</b>	<b>CAM7</b>	<b>CAM8</b>
<b>NON</b>	<b>NON</b>	<b>NON</b>	<b>NON</b>

}

<b>C001 : AW-UE70</b>		<b>TALLY:</b> 	
<b>CONNECT SETTING</b>		<b>17/17</b>	
<b>CAM189</b>	<b>CAM190</b>	<b>CAM191</b>	<b>CAM192</b>
<b>NON</b>	<b>NON</b>	<b>NON</b>	<b>NON</b>
<b>CAM193</b>	<b>CAM194</b>	<b>CAM195</b>	<b>CAM196</b>
<b>NON</b>	<b>NON</b>	<b>NON</b>	<b>NON</b>
<b>CAM197</b>	<b>CAM198</b>	<b>CAM199</b>	<b>CAM200</b>
<b>NON</b>	<b>NON</b>	<b>NON</b>	<b>NON</b>

\_\_\_ indicates factory default settings.

Item	Setting value	Setting details
<b>CAM SEL</b>	CAM1 ⋮ CAM200	Select the camera control number for which you want to configure settings. The network settings for the selected camera control number will appear in the screens that follow.
<b>CONNECT MODE</b>	Serial LAN	Select the connection mode for the camera.
<b>CAM1</b>	NON Serial LAN	Displays the connection mode for camera 1 to camera 200.
<b>CAM2</b> ⋮ <b>CAM5</b>	NON Serial LAN	
<b>CAM6</b> ⋮ <b>CAM200</b>	NON LAN	

■ MANUAL IP SET/USER AUTH

<b>C001 : AW-UE70</b>			<b>TALLY:</b>
<b>MANUAL IP SET/USER AUTH</b>			<b>1/2</b>
<b>CAM SEL</b>			
<b>CAM1</b>			
<b>CAM IP</b>			
<b>192</b>	<b>168</b>	<b>0</b>	<b>10</b>
<b>PORT</b>			<b>SAVE</b>
<b>80</b>			<b>(push)</b>

<b>C001 : AW-UE70</b>		<b>TALLY:</b>
<b>MANUAL IP SET/USER AUTH</b>		<b>2/2</b>
<b>USER NAME</b>		
<b>PASSWORD</b>		
<b>RETYPE PASSWORD</b>		<b>SAVE</b>
		<b>NO?</b>

\_\_\_ indicates factory default settings.

Item	Setting value	Setting details
<b>CAM SEL</b>	<u>CAM1</u> ⋮ CAM200	Select the camera control number for which you want to configure settings. The setting ranges are as follows. Camera 1 to Camera 200 The network settings for the selected camera control number will appear in the screens that follow.
<b>CAM IP</b>		Sets the IP address of the camera. The setting ranges are as follows. (IP addresses are assigned in order starting with 192.168.0.10 for CAM1 under factory default conditions.)
<b>PORT</b>	1 ⋮ <u>80</u> ⋮ 65535	Sets the port number of the camera.
<b>SAVE</b>	<u>(push)</u>	Press the F4 dial so the IP address and port number for the camera are set. ● Settings are not updated until [SAVE] is executed after the settings are changed.
<b>USER NAME</b>		Enter the user name that is registered in the camera to be connected. Turn the F1 dial to select a single character. Press the F1 dial to set each character and enter the following values. Use the F2 dial to delete a single character. ● Use [SAVE] to set the entry.
<b>PASSWORD</b>		Enter the password that is registered in the camera to be connected. Turn the F1 dial to select a single character. Press the F1 dial to set each character and enter the following values. Use the F2 dial to delete a single character. ● Use [SAVE] to set the entry.
<b>RETYPE PASSWORD</b>		Enter the password again.

■ AUTO IP SET

<b>C001 : AW-UE70</b>		<b>TALLY:</b> 	
<b>AUTO IP SET</b>		<b>1/1</b>	
<b>AUTO SET</b>	<b>NEW</b>	<b>TOTAL</b>	<b>EXEC</b>
<b>RENEW</b>	<b>0</b>	<b>0</b>	<b>NON</b>

\_\_\_ indicates factory default settings.

Item	Setting value	Setting details
<b>AUTO SET</b>	NON RENEW KEEP	<p><b>NON:</b> No search is made for remote cameras.</p> <p><b>RENEW:</b> The unit first searches within the same subnet. After this, each detected remote camera is allocated a camera number in order. At this time, each remote camera IP address is overwritten with the connection destination IP address value set for each camera number in the unit.</p> <p><b>KEEP:</b> The unit first searches within the same subnet. After this, newly detected remote cameras are linked with camera numbers whose connection type is set as [NON] on this unit. At this time, the IP addresses set for the remote cameras are saved as they are and the connection destination IP addresses set in this unit are overwritten.</p>
<b>NEW</b>	0	The number of newly detected cameras is displayed.
<b>TOTAL</b>	0	The number of all devices currently being managed by the unit + Number of newly detected devices is displayed.
<b>EXEC</b>	NON RETRY SETTING	<p><b>NON:</b> IP address setting operation is not performed.</p> <p><b>RETRY:</b> Execute the [RENEW] or [KEEP] process again.</p> <p><b>SETTING:</b> The results of [RENEW] or [KEEP] are reflected. With [RENEW], the IP on the camera is also changed at this time. ● Refer to "Setting the IP addresses automatically (auto IP setting)" (page 30) for details.</p>

■ RP IP SET

<b>C001 : AW-UE70</b>			<b>TALLY:</b>
<b>RP IP SET</b>			<b>1/3</b>
<b>NETWORK SETTING</b>			<b>SAVE</b>
<b>STATIC</b>			<b>(push)</b>
<b>IP</b>			
<b>192</b>	<b>168</b>	<b>0</b>	<b>9</b>
<b>SUBNET</b>			
<b>255</b>	<b>255</b>	<b>255</b>	<b>0</b>

<b>C001 : AW-UE70</b>			<b>TALLY:</b>
<b>RP IP SET</b>			<b>2/3</b>
<b>GATEWAY</b>			
<b>192</b>	<b>168</b>	<b>0</b>	<b>1</b>
<b>PORT C1</b>	<b>PORT C2</b>	<b>PORT C3</b>	<b>PORT C4</b>
<b>61000</b>	<b>61002</b>	<b>61004</b>	<b>61006</b>
<b>PORT C5</b>			
<b>61008</b>			

<b>C001 : AW-UE70</b>			<b>TALLY:</b>
<b>RP IP SET</b>			<b>3/3</b>
<b>MAC ADDRESS</b>			
<b>**_**_**_**_**_**_**</b>			

\_\_\_ indicates factory default settings.

Item	Setting value	Setting details
<b>NETWORK SETTING</b>	STATIC DHCP	Select whether to make the IP address setting for the unit by obtaining from the DHCP server [DHCP] or setting with manual [STATIC].
<b>SAVE</b>	(push)	Press the F4 dial so the IP address and port number for the camera are set. ● Settings are not updated until [SAVE] is executed after the settings are changed.
<b>IP</b>	<u>192.168.0.9</u>	Sets the IP address of the unit. ● This is disabled when the setting for [NETWORK SETTING] is [DHCP].
<b>SUBNET</b>	<u>255.255.255.0</u>	Sets the subnet mask of the unit.

Menu (continued)

Item	Setting value	Setting details
GATEWAY	<u>192.168.0.1</u>	Sets the default gateway of the unit.
PORT C1	61000	It is possible to allocate reception port numbers for each camera selection button.
PORT C2	61002	
PORT C3	61004	
PORT C4	61006	
PORT C5	61008	
MAC ADDRESS	—	Display the unit's MAC address. (Display only)

■ TRACKING

<b>C001 : AW-UE70</b>		<b>TALLY:</b> 	
<b>TRACKING</b>		<b>1/1</b>	
<b>TRACKING CONT</b>			<b>SAVE</b>
<b>LAN</b>			<b>(push)</b>
<b>IP</b>			
<b>192</b>	<b>168</b>	<b>0</b>	<b>210</b>
<b>PORT</b>			
<b>1337</b>			

— indicates factory default settings.

Item	Setting value	Setting details
TRACKING CONT	<u>NON</u> LAN	Connection with automatic tracking software becomes possible by selecting [LAN].
SAVE	(push)	Maintain the connection settings of the automatic tracking software. ● Settings are not updated until [SAVE] is executed after the settings are changed.
IP	192.168.0.210	Set the IP address of the automatic tracking software.
PORT	1 ⋮ <u>1337</u> ⋮ 65535	Set the PORT number of the automatic tracking software.



# Setup Software

Setup Software is for the client computer to perform the client computer connection settings with this unit and remote cameras, upgrade of the unit firmware, and backing up the settings data. The settings can be configured while confirming each item in a list.

- The settings for connecting the unit with the remote cameras can also be configured using just the unit. For how to configure the settings on the unit, refer to “Settings for connecting with the remote cameras” (page 29).

## Notes

**When using Setup Software to configure the settings from a personal computer, observe the following.**

- Do not perform any operation on the unit.
- Do not start Setup Software on any other computer in the same network.
- Do not use “Easy IP Setup Software”.
- Ensure that no IP addresses are the same.

## Installing the software

This section describes how to install Setup Software.

You can obtain the software from the Service and Support page of the following website.

<https://pro-av.panasonic.net/>

1. Download the Setup Software zip file from the Service and Support page of the website.
2. Double-click the downloaded zip file to decompress the file.
3. Double-click [RP60PCTool\_\*.exe] in the [Setup Software] folder to start the Setup Software.
  - The website has Setup Software for Windows® 7 and Windows® 10.  
The location marked by the asterisk (\*) will be “7” for the Windows® 7 version and “10” for the Windows® 10 version.

## Configuring the settings of the personal computer

Configure the following settings of the personal computer before connecting it to the unit.

- |                        |   |
|------------------------|---|
| <b>IP address</b>      | : Set an IP address that is not a duplicate of the IP address set on the unit or any IP address set on the devices (remote cameras, etc.) connected within the same subnet. |
| <b>Subnet mask</b>     | : Set the same subnet mask as that set on the unit.   |
| <b>Default gateway</b> | : Set the same default gateway as that set on the unit.   |

You can view the IP address, subnet mask and default gateway set in the unit with [SYSTEM] > [RP IP SET].

- |                        |                  |
|------------------------|------------------|
| <b>IP address</b>      | : [IP] item      |
| <b>Subnet mask</b>     | : [SUBNET] item  |
| <b>Default gateway</b> | : [GATEWAY] item |

## Setup Software (continued)

The screens of Windows 10 are used in the explanations in this manual.

If you are using an operating system other than Windows 10, some of the items displayed on the screens may differ.

### Settings for connecting with the remote cameras

- When connecting with the remote camera, select [MAINTENANCE] > [RP SETTING] of the unit and register the ID and password in advance. (page 53)
- When using Setup Software, select [MAINTENANCE] > [RP SETTING] > [PC\_TOOL LINK] of the unit and set [ENABLE]. (page 53)
- If you forget the ID or password, execute initialization on this unit with [MAINTENANCE] > [RP INITIALIZE] > [INIT ALL], then reset the ID and password.

Note that when this operation is performed, all the setting values on this unit are returned to the factory defaults.

### Displaying the [Setting] tab

RP60 Setup Software

1 IP: 192 . 168 . 0 . 9

2 ID: \_\_\_\_\_

3 PASSWORD: \_\_\_\_\_

Setting | Auto IP Cam Assign | Preset Name | User Auth. | Update | Data

4 CAMERA GROUP	5 CAMERA NO	6 CNTRL TYPE	7 CAMERA NAME	8 MAC ADDRESS	9 IP ADDRESS	10 CAMERA PORT NO	11 SWAP CAMERA
1 [1-5]	CAM1	NoAssign		00:00:00:00:00:00	0 . 0 . 0 . 0	80	
	CAM2	NoAssign		00:00:00:00:00:00	0 . 0 . 0 . 0	80	
	CAM3	NoAssign		00:00:00:00:00:00	0 . 0 . 0 . 0	80	
	CAM4	NoAssign		00:00:00:00:00:00	0 . 0 . 0 . 0	80	
	CAM5	NoAssign		00:00:00:00:00:00	0 . 0 . 0 . 0	80	
2 [6-10]	CAM6	NoAssign		00:00:00:00:00:00	0 . 0 . 0 . 0	80	
	CAM7	NoAssign		00:00:00:00:00:00	0 . 0 . 0 . 0	80	
	CAM8	NoAssign		00:00:00:00:00:00	0 . 0 . 0 . 0	80	
	CAM9	NoAssign		00:00:00:00:00:00	0 . 0 . 0 . 0	80	
	CAM10	NoAssign		00:00:00:00:00:00	0 . 0 . 0 . 0	80	
3 [11-15]	CAM11	NoAssign		00:00:00:00:00:00	0 . 0 . 0 . 0	80	
	CAM12	NoAssign		00:00:00:00:00:00	0 . 0 . 0 . 0	80	
	CAM13	NoAssign		00:00:00:00:00:00	0 . 0 . 0 . 0	80	
	CAM14	NoAssign		00:00:00:00:00:00	0 . 0 . 0 . 0	80	
	CAM15	NoAssign		00:00:00:00:00:00	0 . 0 . 0 . 0	80	
4 [16-20]	CAM16	NoAssign		00:00:00:00:00:00	0 . 0 . 0 . 0	80	
	CAM17	NoAssign		00:00:00:00:00:00	0 . 0 . 0 . 0	80	
	CAM18	NoAssign		00:00:00:00:00:00	0 . 0 . 0 . 0	80	
	CAM19	NoAssign		00:00:00:00:00:00	0 . 0 . 0 . 0	80	
	CAM20	NoAssign		00:00:00:00:00:00	0 . 0 . 0 . 0	80	

RENEW KEEP REFRESH ALL CLEAR SET CANCEL

12 13 14 15 16 17

#### 1 IP

Set the IP address for the AW-RP60 to be connected.

#### 2 ID

Set the ID registered in the AW-RP60 to be connected.

#### 3 PASSWORD

Set the password registered in the AW-RP60 to be connected. The password is displayed as “\*\*”.

When operating the buttons for each menu item (tab), the account information (1 to 3) above is used for the authentication by AW-RP60.

#### 4 CAMERA GROUP

The camera group number is displayed.

#### 5 CAMERA NO

The camera number is displayed.

#### 6 CNTRL TYPE

Select the connection type.

Click  on the right and select the connection type from amongst [Serial], [Network], and [NoAssign].

**Serial** : Serial connection

**Network** : IP connection

**NoAssign** : No setting

Camera numbers [CAM1] to [CAM5] can be selected for [Serial].

#### 7 CAMERA NAME

Displays the camera name set on the remote camera.

- These are displayed when they are acquired with [AUTO IP SET] on the main unit or with [AUTO IP CAM ASSIGN] on this software.

### 8 MAC ADDRESS

Displays the MAC addresses of remote cameras with links set with camera numbers of this unit.

- These are displayed when they are acquired with [AUTO IP SET] on the main unit or with [AUTO IP CAM ASSIGN] on this software.

### 9 IP ADDRESS

Set the IP address of the remote camera that will be the connection destination.

### 10 CAMERA PORT NO

Set the port number of the remote camera that will be the connection destination.

After input, click the [SAVE] button to reflect the changed content.

**Settable range:** 1 to 65535

However, even within this range, the following values cannot be set.

20, 21, 23, 25, 42, 53, 67, 68, 69, 110, 123, 161, 162, 995, 10669, 10670
---

### 11 SWAP CAMERA

You can switch the remote camera set as the connection destination between 2 camera numbers.

Camera numbers [CAM1] to [CAM200] are displayed when  is clicked.

For remote cameras selected as [Serial] in [CNTRL TYPE], you can swap in the range between [CAM1] and [CAM5].

### 12 RENEW button

Executes the AUTO IP (RENEW IP ADR) function of the unit. Then, among the camera numbers of the remote cameras newly detected by the unit, those that can be used to set up connections to the unit are displayed in yellow.

When pressing the SET button, the setting is complete and updated.

### 13 KEEP button

Executes the AUTO IP (KEEP IP ADR) function of the unit. Then, among the camera numbers of the remote cameras newly detected by the unit, those that can be used to set up connections to the unit are displayed in yellow.

When pressing the SET button, the setting is complete and updated.

### 14 REFRESH button

Displays the connection information set in the unit on the [Setting] screen.

### 15 ALL CLEAR button

Clear all setting data.

### 16 SET button

Reflects the set data to AW-RP60.

### 17 CANCEL button

Cancels the settings.



Displaying the [Preset Name] tab

You can set a name of up to 8 characters for a preset number.

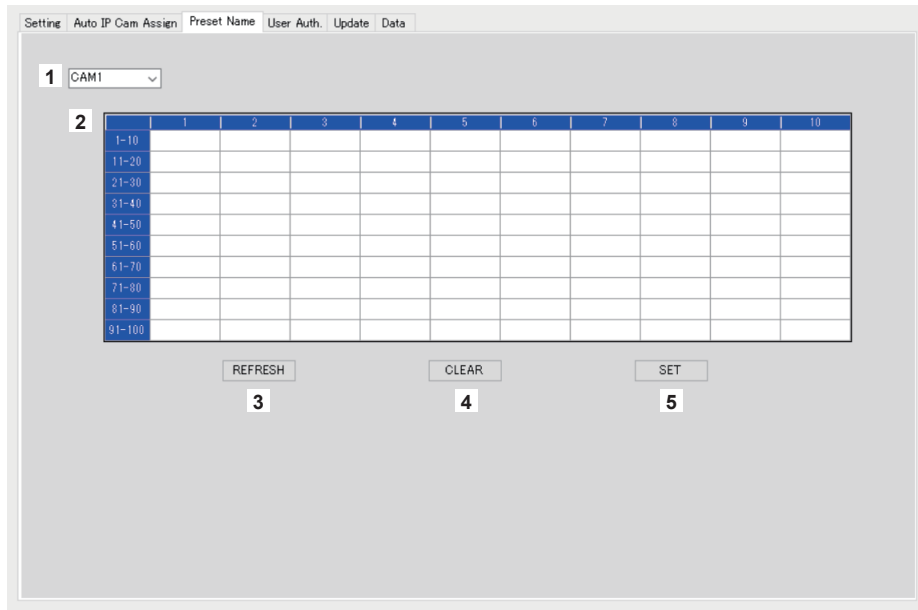

- 1 Camera number**  
Select the camera number for which settings are to be edited.
- 2 Setting area for PRESET names**  
Set a name for each PRESET number.  
When [LOAD] is used to load a file, the name at the time of saving is displayed.  
Names can be a maximum of 8 characters.  
The following characters can be displayed.

Half-size numeric characters	0123456789
Half-size alphabetical characters (upper and lower cases)	ABCDEFGHIJKLMNOPQRSTUVWXYZ abcdefghijklmnopqrstuvwxyz
Symbols	- . _ , + / ( ) [ ] (and spaces)

- 3 REFRESH button**  
Displays the name set in the unit on the [Preset Name] screen.
- 4 CLEAR button**  
Cancels the settings.
- 5 SET button**  
Reflects the set data to AW-RP60.

### Displaying the [User Auth.] tab

Perform user authentication settings for the connection destination remote camera.  
Cameras can be set individually or all at once.

The screenshot shows a software window with a tabbed interface. The tabs are: Setting, Auto IP Cam Assign, Preset Name, User Auth., Update, and Data. The 'User Auth.' tab is active. The main area contains the following elements:

- 1** A dropdown menu with 'ALL' selected.
- 2** A text input field labeled 'New User Name'.
- 3** A text input field labeled 'New Password'.
- 4** A text input field labeled 'Retype New Password'.
- 5** A 'SET' button.

- 1 Camera number**  
Select the camera number for which user authentication is to be set.  
Settings are made all at once if [ALL] is selected.  
When a camera number is selected, the settings can be made for each camera number individually.
- 2 New User Name**  
Set an ID to connect the camera which will be registered as a new camera.
- 3 New Password**  
Set a password to connect the camera which will be registered as a new camera. The password is displayed as “\*”.
- 4 Retype New Password**  
To check, the same password as entered in [New Password] is typed. The password is displayed as “\*”.
- 5 SET button**  
Reflects the set data to AW-RP60.

### Displaying the [Update] tab

Upgrades the software version of the AW-RP60.

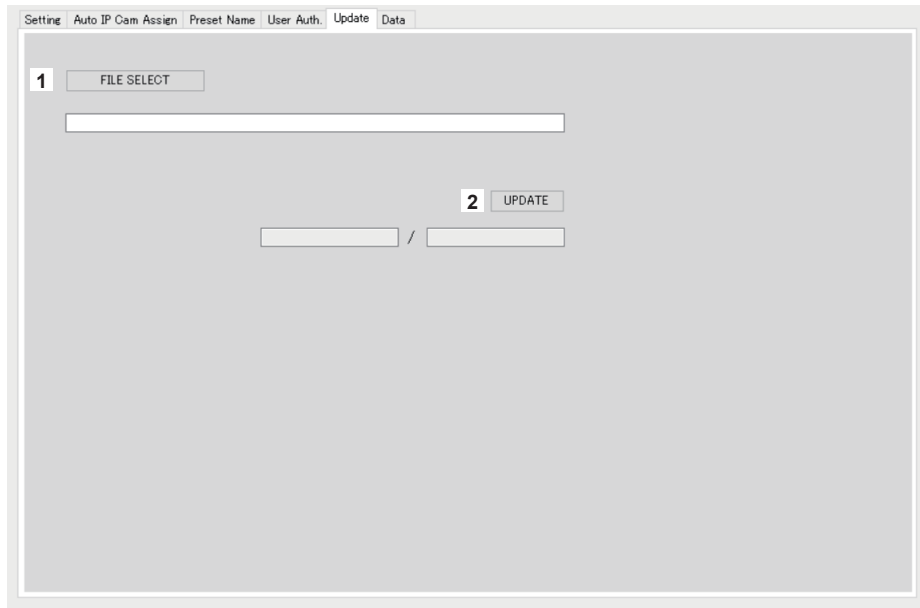

**1 FILE SELECT button**

Selects the file to be used for the upgrade and displays it.

**2 UPDATE button**

Upgrades the software of the AW-RP60.

The status during the upgrade is displayed as transfer data size/data size (the size of the file for upgrading).

Note that if the FPGA version is the same, only the software is upgraded.

After the upgrade is complete, turn the power OFF then ON to restart AW-RP60.

Displaying the [Data] tab

Enables [UPLOAD] and [DOWNLOAD] of AW-RP60 setting data or camera data.



**1 CAMERA DATA**

You can save the SCENE data (SCENE 1 to 4) of the connected camera or settings data (ALL) of the camera. This is only enabled for cameras which support any communication IF available for their SCENE data or settings data.

**2 RP DATA**

Saves the setting data being managed on AW-RP60.

Menus saved

FUNCTION	USER ASSIGN
MAINTENANCE	GPI TALLY GPIO CAM SEL GPO CAM.G GPI PMEM GPI PMEM.G

Menus and items saved

FUNCTION	PTZ INFO1	ZOOM MIN SPD P/T CURVE FOCUS/IRIS
MAINTENANCE	RP SETTING	LCD BRIGHT LED BRIGHT BUZZER GPIO MODE
PMEM	SETTING	RP CTRL SPD MODE
SYSTEM	CAMERA	AUTO POWER
	CONNECT SETTING	CAM1 to CAM200
	MANUAL IP SET/USER AUTH	CAM SEL CAM IP PORT USER NAME PASSWORD
	RP IP SET	NETWORK SETTING SUBNET GATEWAY PORT C1 to PORT C5
	TRACKING	TRACKING CONT IP PORT



### 3 DOWNLOAD button

CAMERA DATA	Saves the settings for remote cameras connected to AW-RP60 to the specified path. The save destination selection dialog is displayed when the <DOWNLOAD> button is pressed. Specify the save destination and the name of the file to be saved.
RP DATA	Saves the AW-RP60 settings to the specified path. The save destination selection dialog is displayed when the <DOWNLOAD> button is pressed. Specify the save destination and the name of the file to be saved.

### 4 UPLOAD button

CAMERA DATA	Uploads data from the specified path to remote cameras that are connected to AW-RP60. The file selection dialog is displayed when the <UPLOAD> button is pressed. Specify the file.
RP DATA	Uploads data from the specified path to the AW-RP60. The file selection dialog is displayed when the <UPLOAD> button is pressed. Specify the file.

# Messages

---

## IP connection settings

Indication	Description
Unavailable network setting	The entered IP address, subnet mask, or port number cannot be set. Enter a correct value. For details, refer to “Network settings of the unit” (page 27).
IP Duplicate!	The entered IP address is a duplicate of the IP address set for another item (the connection destination IP address for another camera number or the IP address of the unit).
Please reboot RP	The unit needs to be rebooted. Turn the unit’s power off and then back on.

## Setup software

Indication	Description
Unavailable network setting.	The entered IP address and port number cannot be set. Set correct values. For details, refer to “Network settings of the unit” (page 27) to “Settings for connecting with the remote cameras” (page 29).
Entered information is incorrect. Enter again.	The entered information includes characters that cannot be used on the unit.
Complete the “New User Name” field.	Enter the user name in the “New User Name” box.
Complete the “New Password” field.	Enter the password in the “New Password” box.
Complete the “Retype New Password” field.	Enter the password in the “Retype New Password” box.
Password entered in the “Retype New Password” field is incorrect.	The password entered in the “Retype New Password” box does not match the one entered in the “New Password” box.

## Troubleshooting

Symptom	Cause and Measure	Reference Page
Cannot turn the power of the unit on.	● Is external DC power being supplied?	–
	● Is the DC plug of the external DC power supply connected to the unit properly?	–
Cannot operate a remote camera.	● Is a power supply connected to the remote camera properly?	–
	● Are the remote camera and unit connected properly?	P. 15 to P. 17
	● Are the connection settings correct?	P. 29 to P. 36
	● Is the remote camera in the standby state? → Turn on the power of the remote camera.	P. 19
	● Is the remote camera selected properly?	P. 21 to P. 22
	● Is the ENABLE button indicator on?	P. 18
	● Has user authentication been set for the remote camera?	P. 78
The remote camera moves in the opposite direction to the operation of the PAN/TILT lever.	● Is the installation method setting configured for the remote camera? → The setting needs to be configured in accordance with the actual installation state (mounted right side up or upside down). Refer to the Operating Instructions for the remote camera.	–
	● Is the movement direction set properly on the unit?	P. 50
The remote camera moves in the opposite direction to operation of the ZOOM button and FOCUS dial.	● Is the movement direction set properly on the unit?	P. 50

# Appearance

Unit: mm (inch)

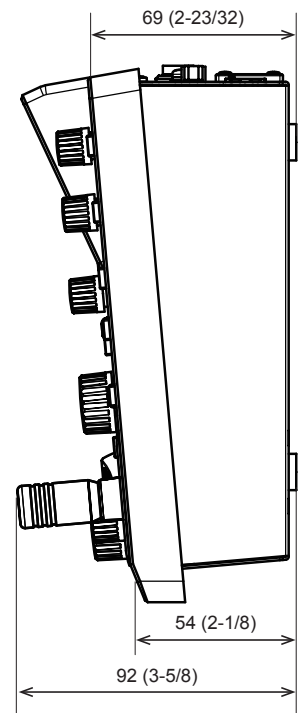
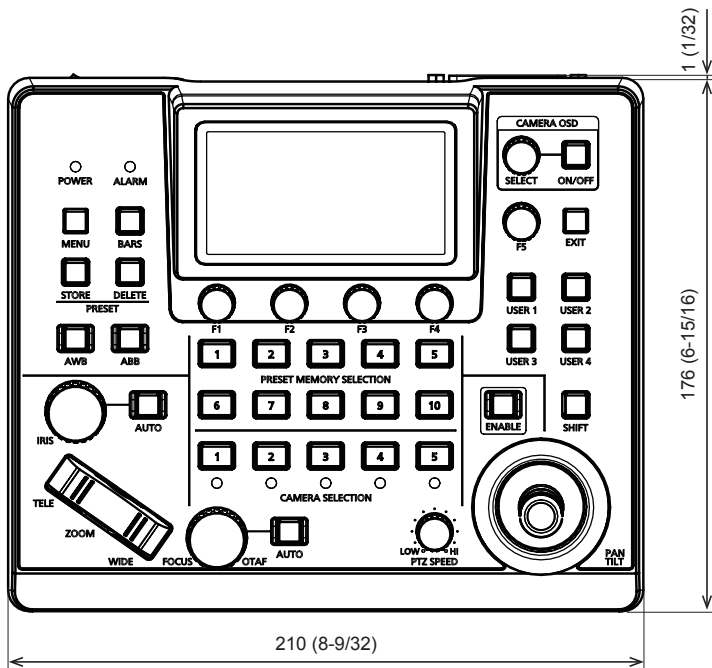
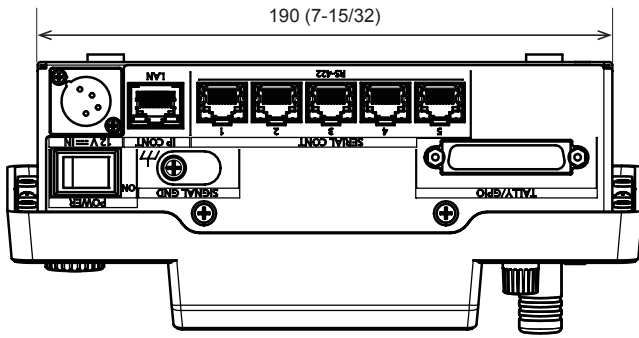

# Specifications

<b>Power supply:</b>	12 V DC (==) (10.8 V to 13.2 V) 42 V - 57 V DC (==) (PoE power supply)
<b>Current consumption:</b>	0.9 A (XLR IN connector) 0.3 A (PoE power supply)

 indicates safety information.

## ■ General

<b>Ambient operating temperature:</b>	0 °C to 40 °C (32 °F to 104 °F)
<b>Allowable humidity:</b>	20% to 90% (no condensation)
<b>Storage temperature:</b>	-20 °C to 50 °C (-4 °F to 122 °F)
<b>Weight:</b>	Approx. 1.5 kg (3.3 lb)
<b>Dimensions (W × H × D):</b>	210 mm × 92 mm × 177 mm (8-9/32 inches × 3-5/8 inches × 6-31/32 inches) (excluding protrusions)

## ■ Input/output connectors

### DC 12 V IN (XLR 4-pin)

### LAN (RJ-45) (with LED):

10BASE-T/100BASE-TX, PoE input  
Connection cable: LAN cable, max. 100 m (328 ft)

- When connecting the unit via a switching hub:  
Straight cable (category 5e), STP (Shielded Twisted Pair) cable recommended
- When connecting the unit directly:  
Crossover cable (category 5e), STP (Shielded Twisted Pair) cable recommended
- REMOTE:  
Available only for LAN (RJ45) control

### SERIAL CONT (RJ-45):

RS-422 (control signals for remote cameras),  
TALLY OUT  
Connecting cable:  
Straight cable (category 5e), max. 1000 m  
(3280 ft)  
TALLY OUT:  
Open collector output (negative logic)  
Maximum voltage resistance DC 24 V, Maximum  
current 50 mA

### TALLY/GPIO (D-sub 25-pin, female, inch thread):

TALLY IN : Contact input (Status operation)  
GPIO IN : Contact input (Trigger operation)  
GPIO OUT : Open collector output (negative logic)  
Maximum voltage resistance DC 24 V, Maximum  
current 10 mA

- Refer to page 86 for details about the pin layout.

## ■ LCD panel

3.5 inch LCD (QHD: 960 × 540)

The symbols on this product represent the following:

 DC
--

# Control interface for external devices

## 1. TALLY/GPIO (JST: JBY-25S-1A3F(LF)(SN))

Select [MAINTENANCE] > [RP SETTING] > [GPIO MODE], then you can assign MODE1 or MODE2 to the settings.

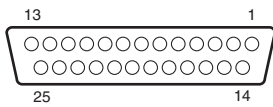

Pin number	Signal name	Description of signal	
		MODE1	MODE2
1	DSU_GPIO_1	R_TALLY_IN1	CAM_SEL_IN1
14	DSU_GPIO_2	R_TALLY_IN2	CAM_SEL_IN2
2	DSU_GPIO_3	R_TALLY_IN3	CAM_SEL_IN3
15	DSU_GPIO_4	R_TALLY_IN4	CAM_SEL_IN4
3	DSU_GPIO_5	R_TALLY_IN5	CAM_SEL_IN5
16	DSU_GPIO_6	G_TALLY_IN1	CAM_GRP_SEL_OUT1
4	DSU_GPIO_7	G_TALLY_IN2	CAM_GRP_SEL_OUT2
17	DSU_GPIO_8	G_TALLY_IN3	CAM_GRP_SEL_OUT3
5	DSU_GPIO_9	G_TALLY_IN4	CAM_GRP_SEL_OUT4
18	DSU_GPIO_10	G_TALLY_IN5	CAM_GRP_SEL_OUT5
6	DSU_GPIO_11	PMEM_GROUP_IN1	CAM_GRP_SEL_OUT6
19	DSU_GPIO_12	PMEM_GROUP_IN2	CAM_GRP_SEL_OUT7
7	DSU_GPIO_13	PMEM_GROUP_IN3	CAM_GRP_SEL_OUT8
20	DSU_GPIO_14	PMEM_GROUP_IN4	PMEM_SEL_IN1
8	DSU_GPIO_15		PMEM_SEL_IN2
21	DSU_GPIO_16	CAM_SEL_OUT1	PMEM_SEL_IN3
9	DSU_GPIO_17	CAM_SEL_OUT2	PMEM_SEL_IN4
22	DSU_GPIO_18	CAM_SEL_OUT3	PMEM_SEL_IN5
10	DSU_GPIO_19	CAM_SEL_OUT4	PMEM_SEL_IN6
23	DSU_GPIO_20	CAM_SEL_OUT5	PMEM_SEL_IN7
11	DSU_GPIO_21		PMEM_SEL_IN8
24	DSU_GPIO_22		PMEM_SEL_IN9
12	DSU_GPIO_23		PMEM_SEL_IN10
25	GND	GND	GND
13	DSU_GPIO_24	ALARM_OUT	ALARM_OUT

### Example of GPI OUT connection

Ensure that the conditions given below are satisfied.

Withstand voltage: Max. 24 V DC  
Current: Max. 10 mA

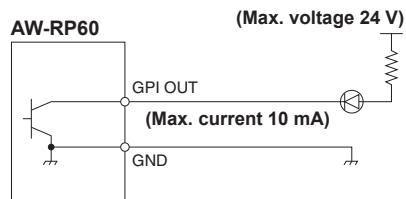

### Example of TALLY IN and GPI IN connections

Provide contact inputs.

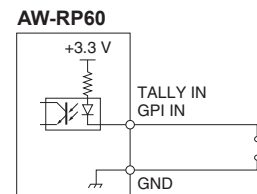

**2. SERIAL CONT 1 to 5 (RJ-45)**

Use LAN cables to connect Panasonic remote cameras with serial (RS422) connections. Connect them with straight cables (category 5e or better shielded cable).

Pin number	Signal name	Description of signal
1	GND	Frame ground
2	TALLY	Tally output (open collector)
3	TXD –	Send data (–)
4	RXD –	Receive data (–)
5	RXD+	Receive data (+)
6	TXD+	Send data (+)
7	NC	Not used
8	NC	Not used

- TALLY (pin number: 2) specifications  
 Voltage withstand: Max. 24 V DC  
 Current: Max. 50 mA

**3. IP CONT (RJ-45)**

Complies with 10BASE-T/100BASE-TX.

Allowing connection to a network device that supports the PoE standard (IEEE802.3af compliant).

**4. 12V ⚡ IN (DC 12 V)**

Hirose Electric: HA16RA-4P (77)

Accepts DC 12 V inputs from an external power supply.

Input voltage range: 10.8 V to 13.2 V

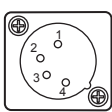
	Pin No.	Function
	1	GND
	2	NC
	3	NC
	4	+12V

# Index

---

<b>A</b>	
Auto IP setting .....	30
AV-HLC100 .....	15
AW-UE70 .....	15, 16, 17
<b>C</b>	
Camera selection section .....	11
Color adjustment section .....	13
Connection destination IP addresses .....	29
<b>D</b>	
Default gateway .....	28
<b>F</b>	
Focus, zoom and iris section .....	12
FUNCTION .....	46
CAMERA INFO .....	48
CROP .....	52
HOUSING .....	51
PTZ INFO1 .....	49
PTZ INFO2 .....	50
USER ASSIGN .....	46
<b>I</b>	
IP address .....	27
IP CONT .....	14, 87
<b>L</b>	
LAN .....	85
LAN cable .....	15, 16, 17
Link settings .....	29
Live Production Center .....	15
<b>M</b>	
MAC address .....	28
MAINTENANCE .....	53
GPIO CAM SEL .....	57
GPI PMEM .....	60
GPI PMEM.G .....	61
GPI TALLY .....	56
GPO CAM.G .....	59
RP INITIALIZE .....	54
RP SETTING .....	53
RP VERSION .....	55
Menu operation section .....	10
<b>P</b>	
PAINT .....	38
CHROMA .....	39
COLOR CORRECT .....	42
CONTRAST .....	45
DNR .....	44
DRS .....	41
DTL .....	42
GAIN .....	40
GAMMA .....	41
PEDESTAL .....	45
SCENE .....	38
SHUTTER .....	39
WHITE BALANCE .....	40
Pan and tilt section .....	11
PMEM .....	63
PMEM LIST .....	64
SETTING .....	65
Preset memory selection section .....	13
<b>R</b>	
Remote camera .....	9
<b>S</b>	
SERIAL CONT .....	14, 85, 87
Setup Software .....	73
Subnet mask .....	27
SYSTEM .....	67
AUTO IP SET .....	70
CAMERA .....	67
CONNECT SETTING .....	68
MANUAL IP SET/USER AUTH .....	69
RP IP SET .....	71
TRACKING .....	72
<b>T</b>	
TALLY/GPIO .....	14, 85, 86
<b>U</b>	
User button section .....	13





**Panasonic Connect Co., Ltd.**

Web Site: <https://pro-av.panasonic.net/en/>

© Panasonic Connect Co., Ltd. 2019 - 2022